

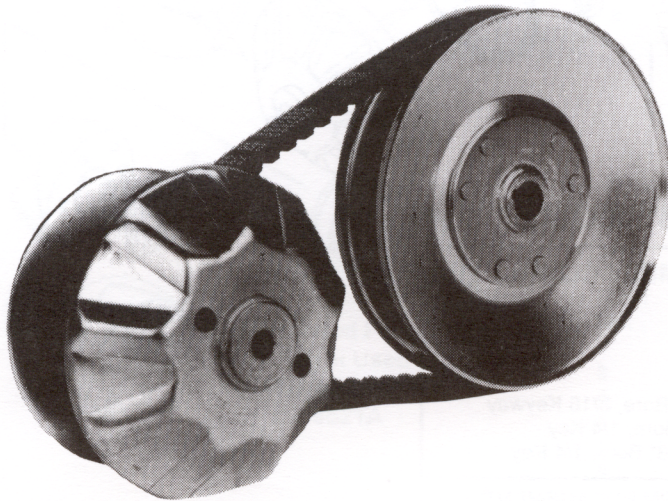

MAGNUM 44 C.V.T.

(CONTINUOUSLY VARIABLE TRANSMISSION) SYMMETRICAL



GENERAL INFORMATION: The Magnum 44 Torque Converter System for up to 18 H.P. applications falls between the models TC20-TC30 at 3 H.P. to 8 H.P. and the 94C - 108EXP series for 25 H.P. and up. A rugged piece of machinery, the drive clutch is designed to withstand the extreme rigors of rough applications. The driven unit is of the same quality construction as the drive clutch. Application possibilities cover a wide range . . . by changing pucks and spring you can convert the Magnum from the standard 4 cycle setup to be used on 2 cycle engines. The Model 44C coupled with either the 40D or 44D is designed for numerous applications including the recreational vehicles such as the big three wheelers, ATV'S, LTV'S and the E.T.V. (Economy Transportation Vehicles). Materials handling and other commercial uses like; oil well pumps, tractors, tillers, mowers, construction equipment, plus industrial equipment. In short, wherever there is a need, want and use for a torque sensitive drive system device that is infinitely variable from engagement to the highest speeds attainable (within the pitch diameter range) . . . this system should be considered.

NOTE: This literature contains information on the 44C Drive Clutch and the 40D and 44D Driven Units, either of which may be used in combination with the 44C Drive Clutch.

44 MAG w/40D		44 MAG w/44D	
SPEED REDUCTION RATIOS			
HIGH	LOW	HIGH	LOW
1:1	2.43:1	1.24:1	2.83:1
OVERALL 2.43		OVERALL 2.29	

RECOMMENDED H.P.
Max. 18 H.P. 4 Cycle
DRIVE BELT: 7/8" Top Width
Symmetrical Type
DRIVE CLUTCH BORE SIZES:
3/4" , 1" , 1 1/8"
40D DRIVEN BORE SIZES:
5/8" 3/4", 7/8" --7 1/2 Dia.
44 D DRIVEN BORE SIZES:
3/4" -- 8 1/2 Dia.



MAGNUM 44C DRIVE CLUTCH ASSEMBLY SEQUENCE

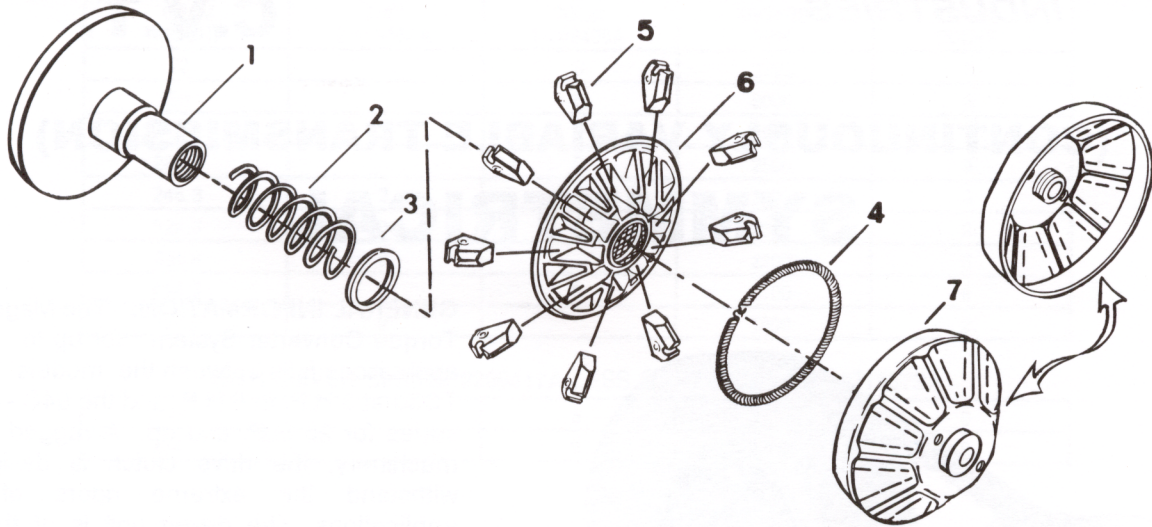

3/4", 1", 1-1/8" BORE*

DRIVE CLUTCH ASSEMBLY COMPLETE

ORDER NO.	DESCRIPTION
209709A	Drive Clutch, 3/4 Bore, 3/16 Keyway
209418A	Drive Clutch, 1" Bore, 1/4 Key
209706A	Drive Clutch, 1 1/8" Bore, 1/4 Key

*CLUTCH SET UP 1900 RPM ENGAGEMENT.

ENGAGEMENT CALIBRATIONS ON BACK OF THIS LITERATURE.

3/4", 1", 1-1/8" BORE

PARTS LIST

ITEM NO.	ORDER NO.	DESCRIPTION	QTY. REQ.
1	209710A	Fixed Face / Post, 3/4 Bore, 3/16 Keyway	1
1	209416A	Fixed Face/ Post, 1" Bore, 1/4 Key	1
1	209707A	Fixed Face / Post, 1 1/8" Bore, 1/4 Key	1
2	203039A	Spring, Green	1
3	209421A	Washer, Thrust	1
4	211573A	Garter Spring, White	1
5	209855A	Puck	9
6	209413A	Face, Movable w/Bearing	1
7	209412A	Cover Plate with Threaded Pilot Washer	1

NOTE: MOUNTING BOLT NOT INCLUDED. USE BOLT LONG ENOUGH TO ENGAGE THREADS IN CRANK AT LEAST 2 1/2 TIMES BOLT DIAMETER.

40/44D ASSEMBLY SEQUENCE

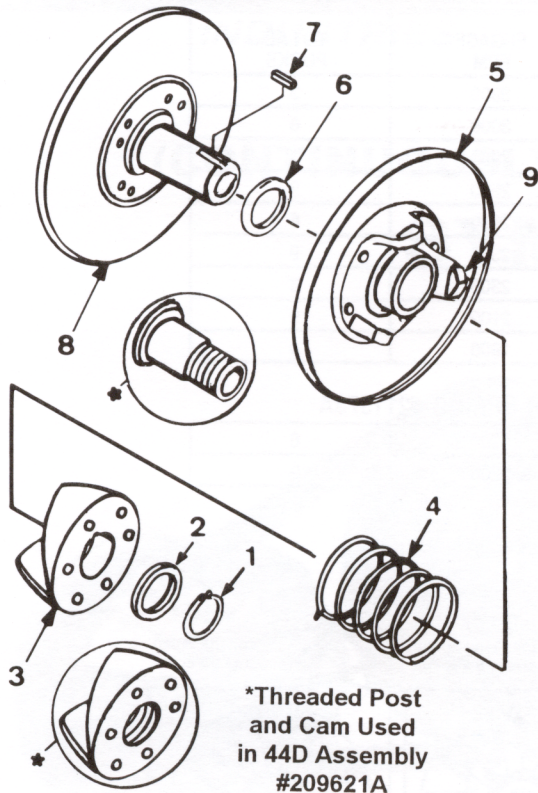

40 DRIVEN UNITS, 7/8 BELT --- 7 1/2" Dia.

ORDER NO.	DESCRIPTION
209151A	Driven Unit, 5/8 Bore, 3/16 Keyway
209133A	Driven Unit, 3/4 Bore, 3/16 Keyway
209139A	Driven Unit, 7/8 Bore, 3/16 Key

PARTS LISTS

ITEM NO.	ORDER NO.	DESCRIPTION	PART USED ON DRIVEN UNIT(S) LISTED BELOW
1	203159A	Ring, Retaining	ALL 40D
2	205208A	Washer, Thrust	ALL 40D
3	209115A	Cam, Fixed	ALL 40D
4	203130A	Spring, Red	ALL 40D
5	209128A	Movable Face and Cam with Bearing	ALL 40D
6	203097A	Spacer	ALL 40D
7	209166A	Key, 3/16 Sq. x 1/2	209151A-209133A
8	209150A	Fixed Face & Post 5/8 Bore x 3/16 Keyway	209151A
8	209132A	Fixed Face & Post 3/4 Bore x 3/16 Keyway	209133A
8	209138A	Fixed Face & Post 7/8 Bore x 3/16 key	209139A
9	206458A	Button (3)	ALL 40D

44 DRIVEN UNITS 7/8 BELT -- 8 1/2" Dia.

ORDER NO.	DESCRIPTION
209621A	Driven Unit, 3/4 Bore, Threaded Post & Cam

PARTS LIST

ITEM NO.	ORDER NO.	DESCRIPTION	PARTS USES ON DRIVEN UNIT(S) LISTED BELOW
3	206521A	Cam, Fixed, Threaded Cam	209621A
4	203130A	Spring, Red	209621A
5	209620A	Movable Face and Cam with Bearing	209621A
8	209619A	Fixed Face & Post, 3/4 Bore, Threaded Post	209621A
9	206458A	Button (3)	209621A

RECOMMENDED BELT SPECIFICATIONS 40/44 SERIES — SYMMETRIC

COMET Order No.	COMET No. Marked On Belt	40 C.D. Setting	44 C.D. Setting	Belt O.C.
203783A	40-75	7-1/4"		31.950
203784A	40-80	7-7/8"		32.900
203785A	40-85	8-3/16"		33.870
203786A	40-90	8-5/8"	7-5/8"	34.830
203787A	40-95	9-3/8"	8-3/16"	35.800
203788A	40-100	9-3/4"	8-11/16"	36.780
203792A	40-105	10-1/4"	9-3/16"	37.750
203789A	40-110	10-1/2"	9-5/8"	38.650
203790A	40-120	11-1/2"	10-9/16"	40.500
203791A	40-130	12-5/8"	11-11/16"	42.660
204331A	40-140	13-3/4"	12-5/8"	44.530
213165A	44-85	15-3/16"	14-7/32"	47.500
213295A	44-75	14-11/32"	13-13/32"	45.380

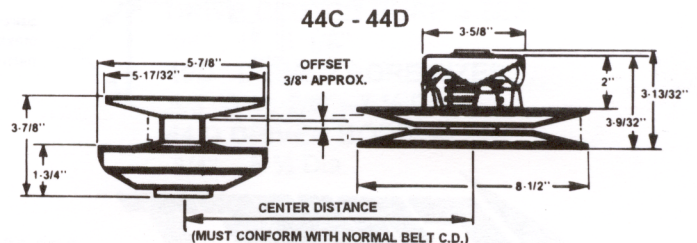
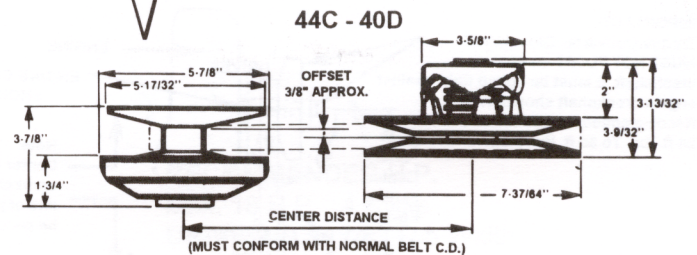
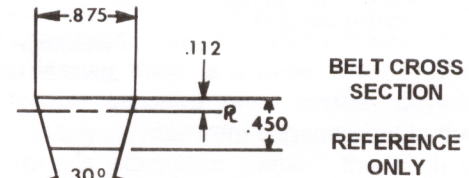

NOTE: DIMENSIONS AND RATIOS ARE IN ACCORDANCE WITH ENGINEERING'S DRAWING CURRENT WITH THE DATE SHOWN ON THIS ITEM. SPECIFICATIONS ARE SUBJECT TO CHANGE WITHOUT NOTICE.

MAGNUM 44C CLUTCH — ENGAGEMENT CHART

WITH GREEN SPRING #203039A & WHITE GARTER SPRING #211573A

TOTAL GRAM WEIGHT	RED 3/4" 2-209855A	WHITE SOLID 1-209406A	ENGAGE RPM	TOTAL PUCKS
78		3	3900	3
156		6	3000	6
168.3	3		2900	3
234		9	2500	9
246.3	3	3	2500	6
324.3	3	6	2300	9
336.6	6		2300	6
414.3	6	3	2100	9
504.9	9		1900	9

WITH SILVER SPRING #209417A LESS GARTER SPRING #211573A

156		6	3700	6
234		9	3200	9

CAUTION !
Three IDENTICAL Pucks
= One Set

Always form an
EQUAL TRIANGLE with
each set of three (3)
IDENTICAL PUCKS
being installed.

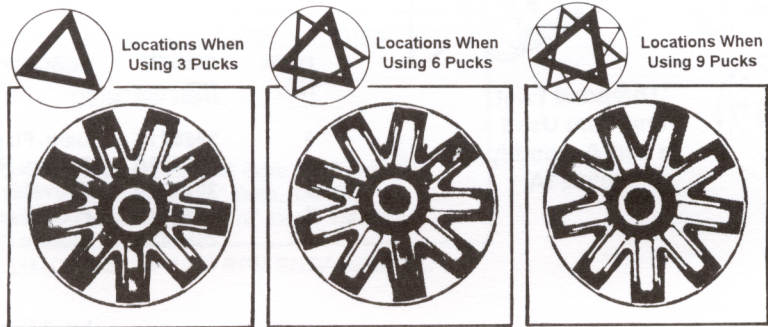

Warning! When 2 or more puck types are to be used at the same time, each type must be installed as shown above, in mated sets of 3.

SYSTEM INSTALLATION INSTRUCTIONS

IMPORTANT!
Torque Converter DRIVE UNIT
MUST NOT FLOAT on engine
crankshaft. It must be bolted tight against
engine crankshaft shoulder.
Recommended Torque for bolt:
24 ft. lbs. To 30 ft. lbs. Max

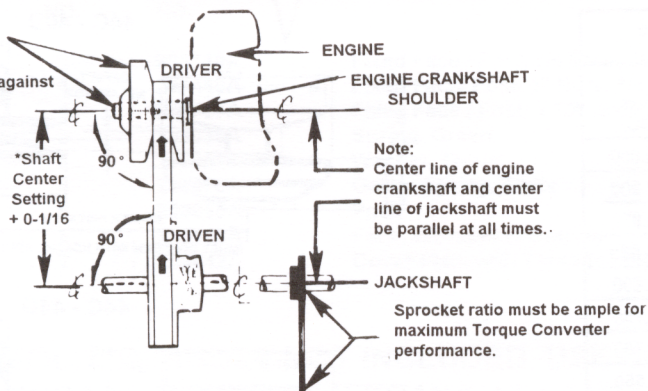

ADJUSTING THE SPRING TENSION OF THE DRIVEN UNIT

NOTE: By increasing the spring tension of the torque sensing system . . . the power ratio of the system (Driver and Driven) can be held longer at higher engine r.p.m.'s before it is overcome by the clutch driver.

To shorten the time required for the driven member to attain it's speed ratio, **DECREASE** the amount of spring tension of the torque sensing cams. This will allow the r.p.m. of the drive clutch to overcome the power ratio of the driven unit at a faster rate in a lower r.p.m. range.

COMET
INDUSTRIES

358 NW F Street Richmond, IN 47374-2297
(765) 966-8161 Fax: (765) 935-2346
<http://www.hoffcocomet.com>