

SALSBUURY

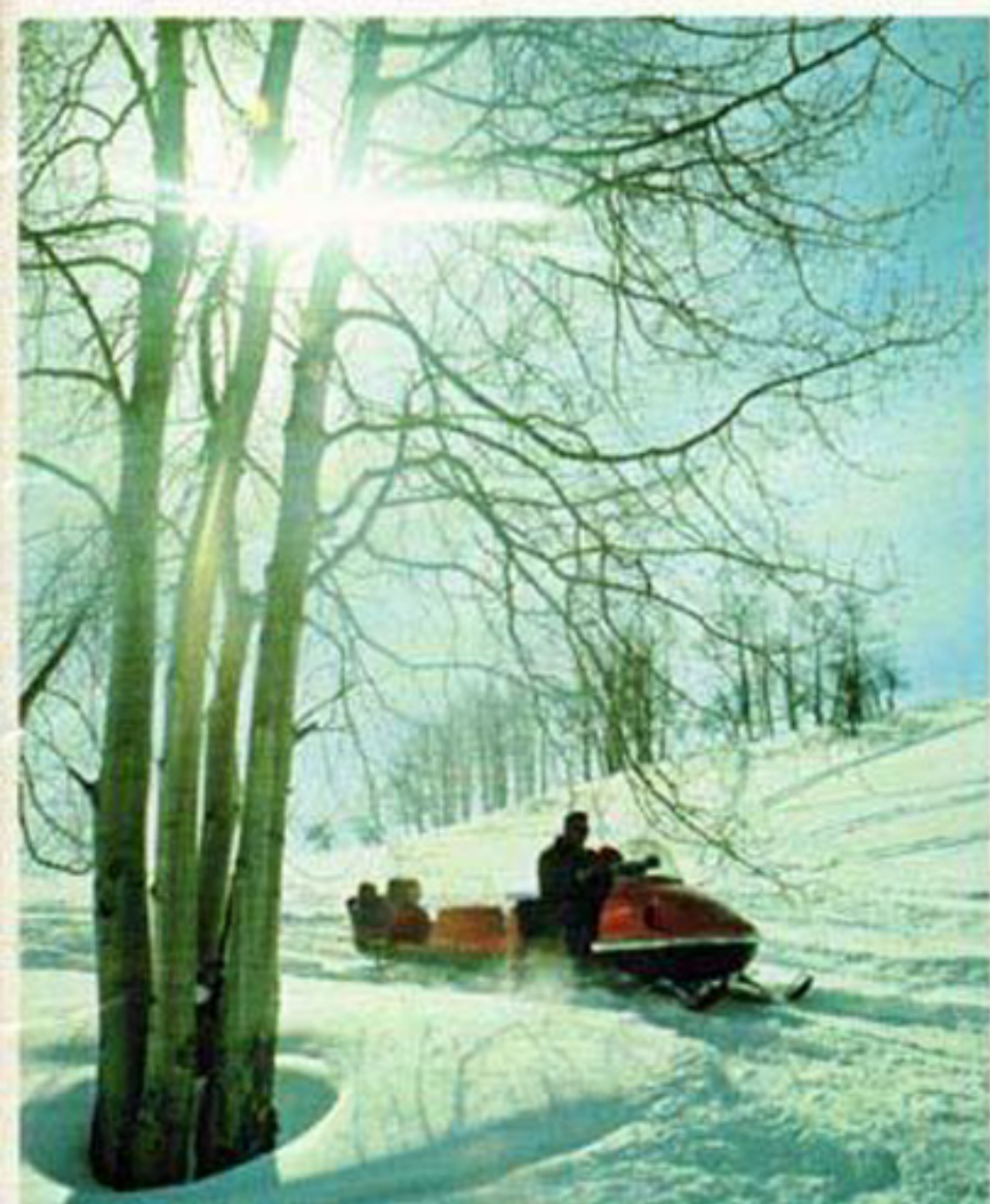

AUTOMATIC DRIVES ▶



SALSBURY

AUTOMATIC

What It Is:

The Salsbury Automatic Torque Converter is a simple device — basically a variable pitch, belt-type drive. This automatic drive has been continually improved from the original design put into production at the Salsbury Plant **more than 30 years ago!** Ever increasing applications and wider customer acceptance have multiplied the demand for this drive ever since its inception. What are the reasons for its increasing popularity?

First, the drive is fully automatic — operating both as a clutch and a transmission. It is easily controlled by the engine's throttle.

Second, it is a simple device — completely mechanical and occupying minimum space. It can also operate mounted in any position.

Third, by downshifting automatically, it not only improves braking, but offers better vehicle control as well.

Fourth, although it is a low cost drive, it does not compromise performance. Its design provides optimum ratio selection between engine and drive wheel automatically.

Fifth, because Salsbury drives do continually select the proper drive ratio without manual shifting by the operator, life of the driving components (chain, sprocket, bearings, etc.) is lengthened, affording even greater economy for this drive.

Salsbury transmission equipment has proved its superior performance in hundreds of applications . . . from golf carts to snow vehicles, from air compressors to vibrating compactors, from mini-bikes to personnel carriers . . . wherever there's a need for positive power control.

MODEL 910 — Demonstrates Typical Converter Components

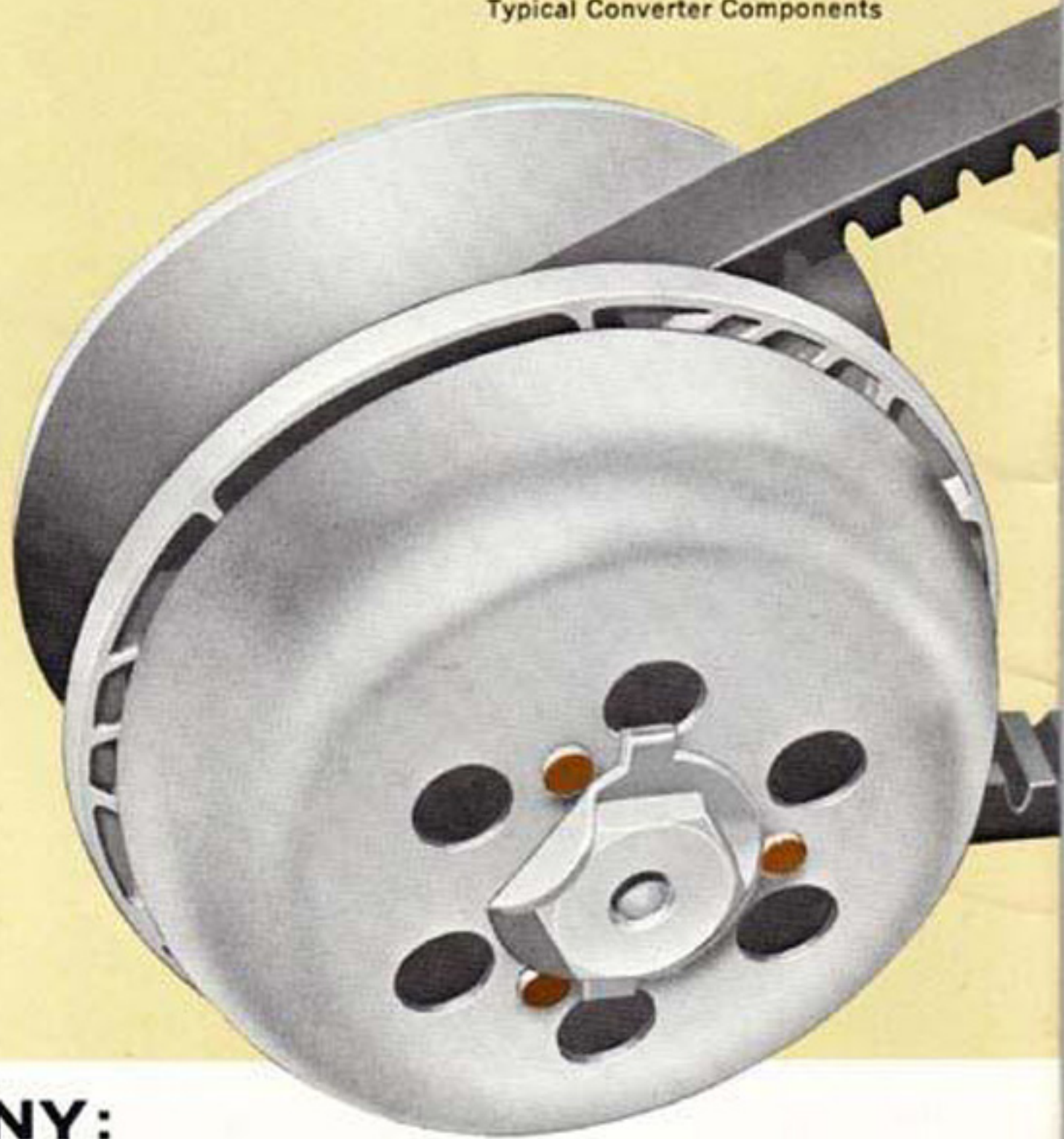

ABOUT THE COMPANY:



In 1936, America's first motor scooter was introduced by Salsbury Corporation. One of the earliest converters for these vehicles is pointed out in this photo.

Foster Salsbury founded Salsbury Corporation in 1936 to manufacture this nation's first motor scooters. A basic variable speed drive system was required which led to the development of the first Salsbury automatic torque converter in 1937.

Rapid growth and diversification during World War II led to such other products as automatic clutches, pneumatic air hammers, tire changing and retreading equipment, wind tunnels, scooter-type mono-ambulances, turret trucks, and an improved method of reconditioning cracked motor blocks and cylinder heads.

Following World War II, the demand for Salsbury power transmission equipment by manufacturers of other type recreational and utility vehicles caused Salsbury to concentrate production on these products. Today, Salsbury is an important division of Instrument Systems Corporation, maintaining its position as the first and the nation's leading manufacturer of automatic torque converters for recreational, industrial and utility vehicles.



E. Foster Salsbury
President
Salsbury Corporation

Copyright 1970 — Salsbury Corporation

TORQUE CONVERTER



- AUTOMATIC
- SIMPLE
- DEPENDABLE
- QUIET
- ECONOMICAL

BASIC SPECIFICATIONS

ENGINE RATINGS

2-Cycle: 3 to 85 horsepower*

4-Cycle: 2 to 25 horsepower*

DRIVING RATIOS

(Typical) — 3:1 at engagement (low)
up to 1:1 (high)*

ENGAGEMENT RPM

2-Cycle (typical): 2800 r.p.m.

4-Cycle (typical): 2000 r.p.m.

MAXIMUM SPEED

Normally 6000 r.p.m.*

*Modified units with higher ratings are available for racing and other extraordinary requirements. (Refer to Engineering Dept.)

DESIGNED FOR OFF-THE-ROAD VEHICLES

RECREATIONAL ■ INDUSTRIAL ■ AGRICULTURAL



POSTAL TRUCKS



OFF-THE-ROAD VEHICLES

SNOWMOBILES

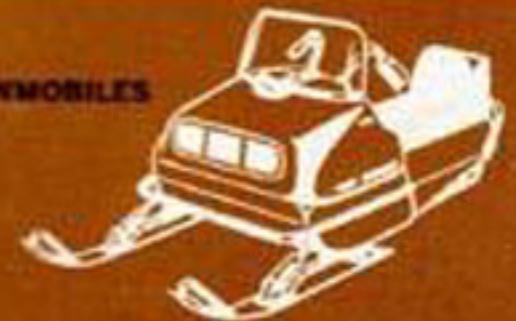

CEMENT BUGGIES



MINI-BIKES



AMPHIBIOUS VEHICLES



MINI-CARS

SALSBUURY

How It Works:

MODEL 910 — Typical
Torque Sensitive
Type Converter

OPTIONAL PULLEY BORE SIZES, TAPER, OR INTEGRAL SHAFT

To adapt to a variety of engine designs, the driver pulley is offered with several diameter bore sizes, step bores, or 1:10 taper. The driven pulley is also available with optional bore sizes or an integral, splined shaft. Belts for optional pulley center distances are offered as well.

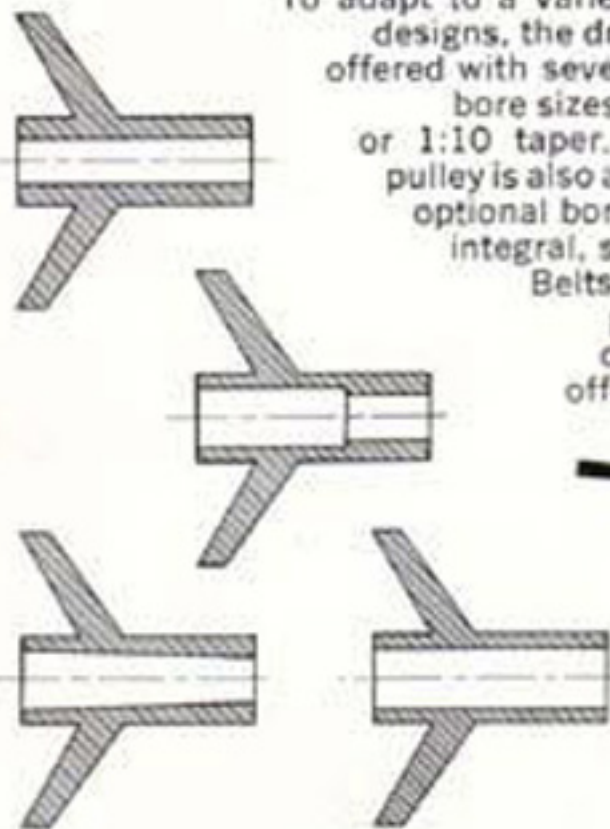

DRIVER PULLEY

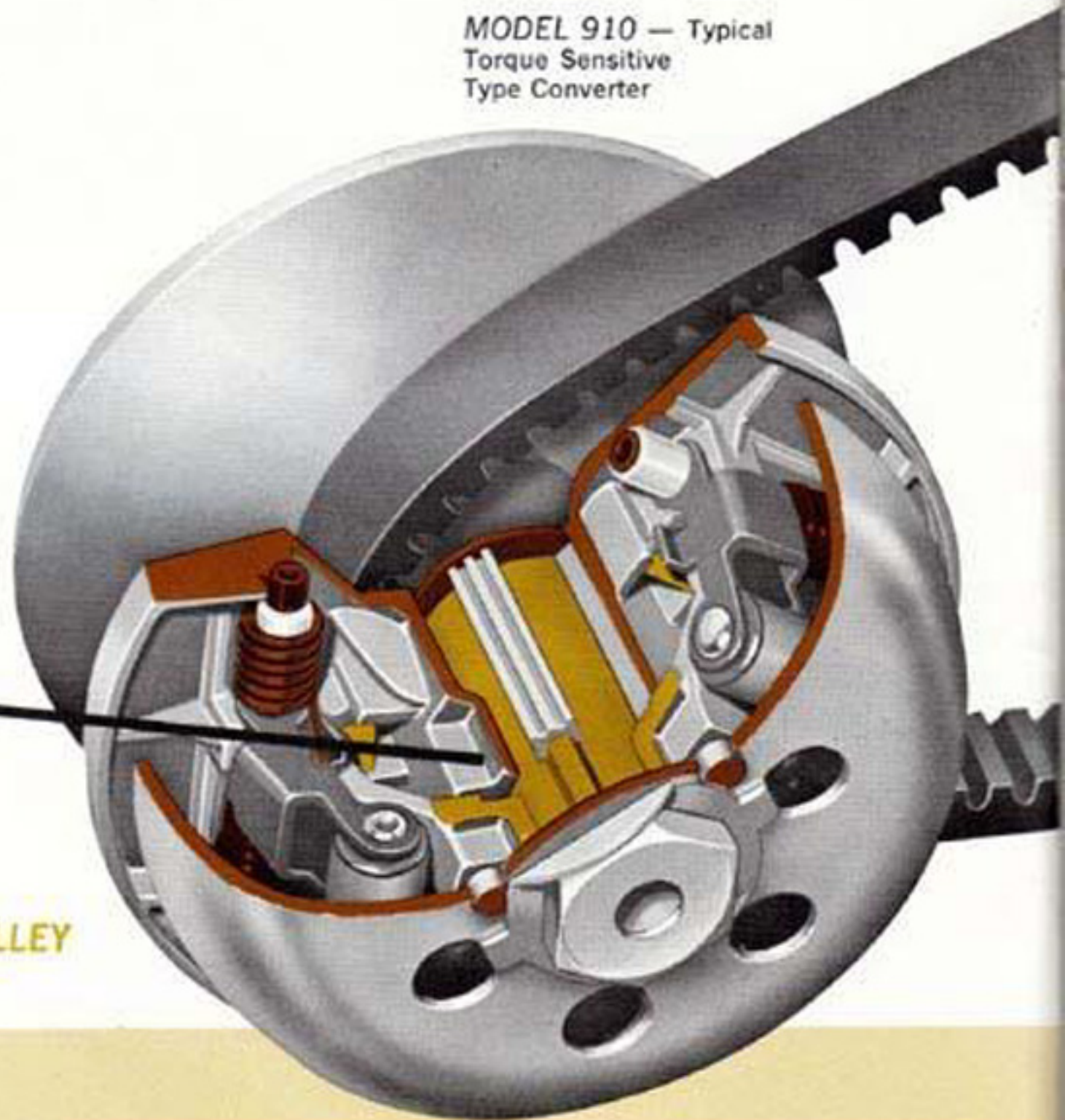

DRIVER PULLEY



AT IDLE (In "Neutral")

At idle, the driver pulley is at the reduced engine speed; the driven pulley is stopped. Note the belt is not under tension.

DRIVEN PULLEY

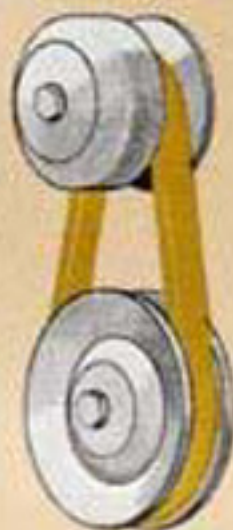

STARTING ("Low Gear")

During start-up, the engine operates at a medium to high speed, the driven pulley at a slow speed for a maximum torque ratio.



HIGH SPEED ("High Gear")

As speed increases, the converter upshifts smoothly and infinitely to a 1:1 ratio or overdrive for maximum speed and cruising economy.

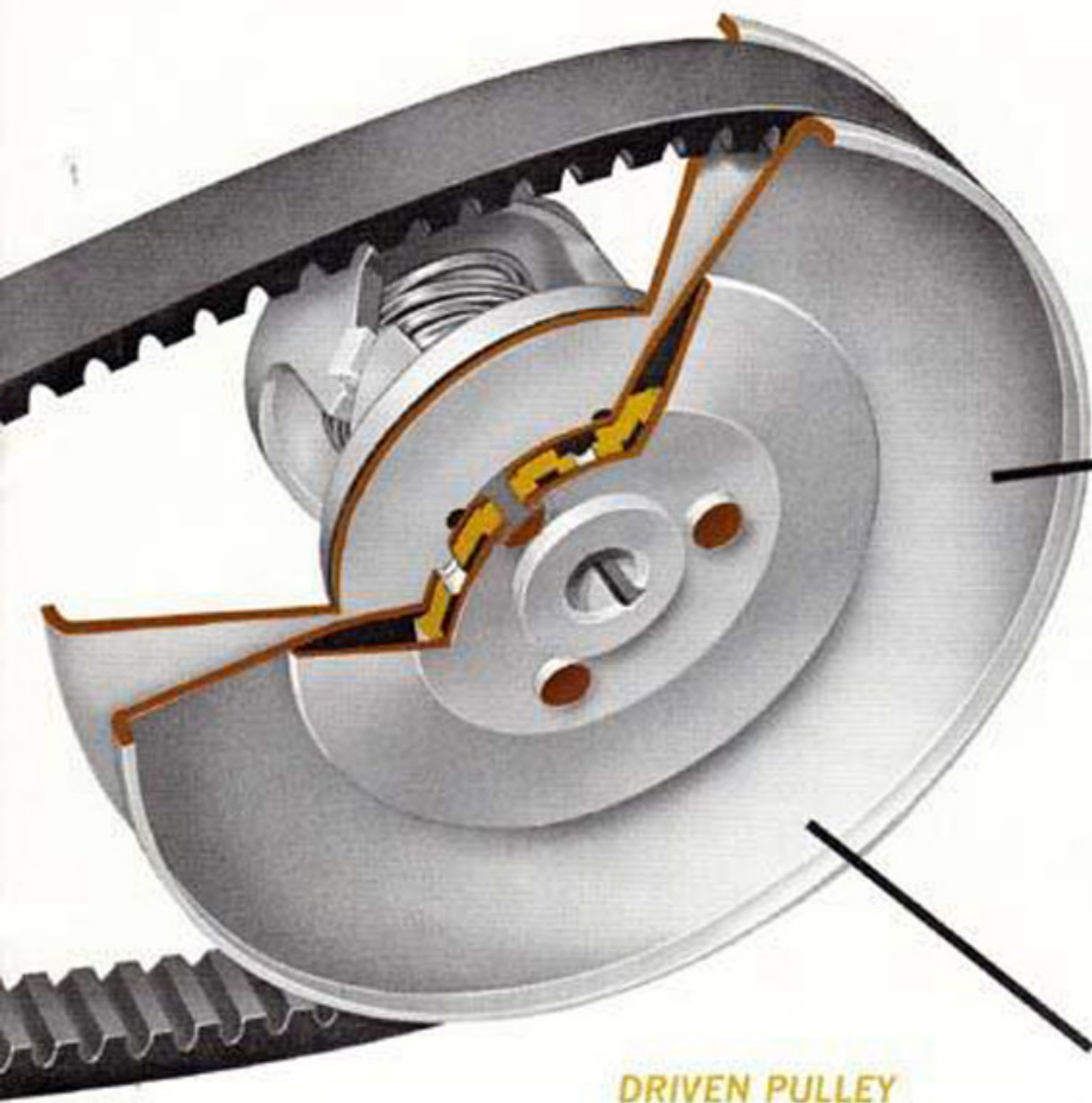

DRIVEN PULLEY

OPTIONAL BRAKE COMPONENTS AVAILABLE

Special driven pulleys are available on Salsbury torque converters to accept braking components. Extended lip designs can be furnished or (on factory order) studs or mounting holes employed to mount brakes hubs, disks, drums, etc. (Refer to Engr. Dept.)

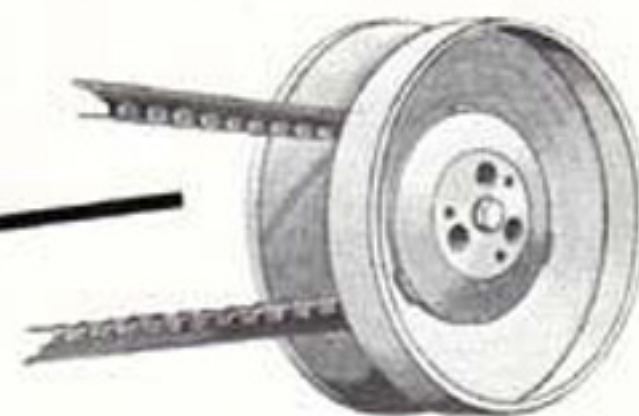

STRONG, LIGHTWEIGHT SHEAVES

Salsbury has developed high strength die-cast aluminum sheaves and stamped steel sheaves to meet the requirements of rugged vehicle operation under all environmental conditions. Modified units also available for racing units.



Two types of driven pulley systems available:

SPEED SENSITIVE

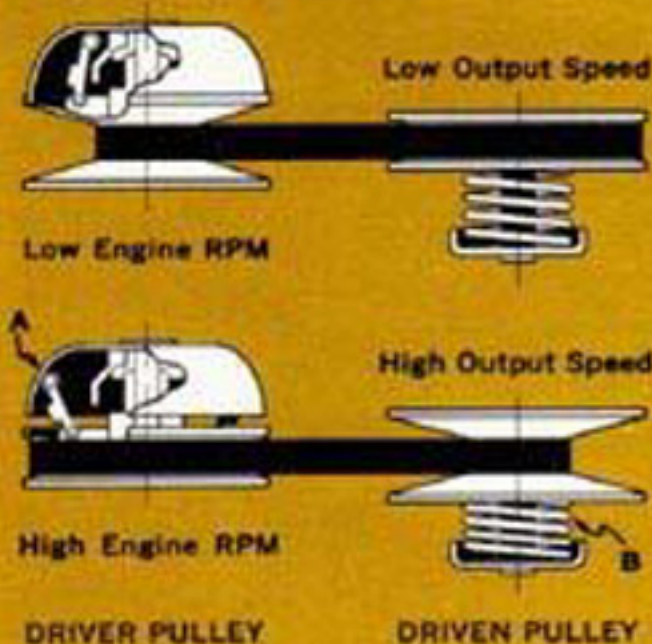

At low speeds the normal position of the driver pulley maintains the V-belt at a smaller diameter which, with the corresponding larger diameter on the driven pulley, creates a "low gear" ratio.

As the speed increases, the centrifugally actuated roller weights (A) follow the contour of the bowl-shaped ramp plate, forcing the driver sheaves together. This action through the belt compresses the driven-pulley spring (B), thus achieving a "high gear" ratio.

TORQUE SENSITIVE

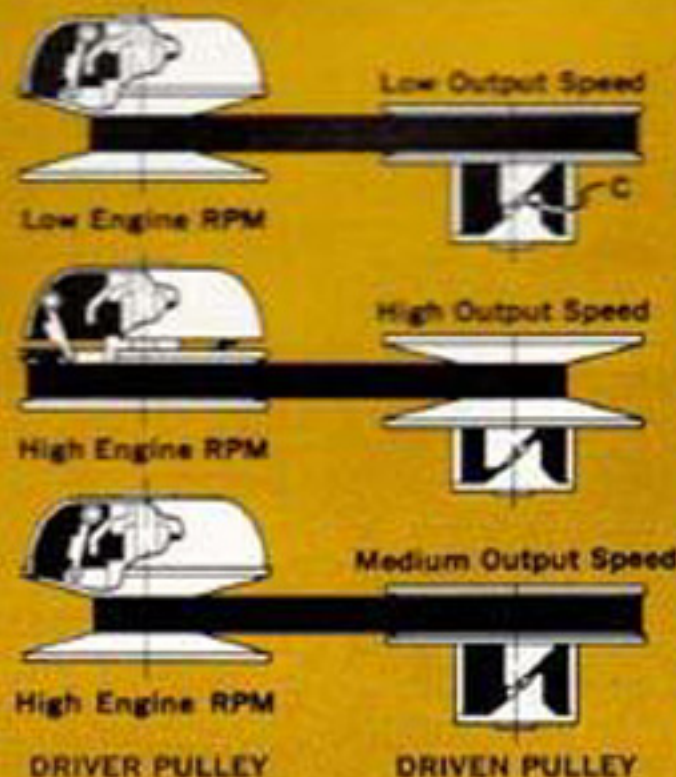

In the torque sensitive design (as in the speed sensitive design) the normal position of the driver pulley at low engine speeds maintains the V-belt in a small diameter. Normal rotational force on cam actuator (C) keeps driven pulley in "low gear" ratio.

As the driver pulley is essentially the same in both type units, higher engine speeds cause the roller weights to close the driver pulley sheaves, creating a "high gear" ratio (note position of cam actuator).

If an increased load occurs (such as climbing a hill) after the vehicle is up to speed, the cam actuator on the driven pulley takes over and automatically "downshifts" without loss of engine speed. The engine remains at peak power range for all but the most severe loads, at which time it will shift into peak torque range.

Where It's Used



SNOWMOBILES

Salsbury was the first manufacturer to provide belt-type automatic torque converters for snowmobiles. Today, it is still the nation's leading supplier of converters for this use. Specially designed snowmobiles with 75 h.p. engines and modified Salsbury torque sensitive drives are now achieving record speeds of nearly 100 mph!



MINI-BIKES

Only a short time ago, Salsbury introduced their Model 330 "Mini-Verter." Already many consider it to be the final answer to the controversy of single, direct-drive, 2 or 3-speed, manual or automatic drives for mini-bikes. This new, reduced size, torque sensitive automatic drive was designed specifically for light horsepower application such as mini-bikes.



SPECIAL SPORTS VEHICLES

Fun vehicles — designed for skimming over sand dunes or traversing a friendly lake demand simplicity and performance. Salsbury's simple belt-type, automatic drive fills the need. For the fun cars of today, or for the fun cars of tomorrow not yet on the drawing boards, Salsbury converters will continue to be the nation's favorite automatic drive.



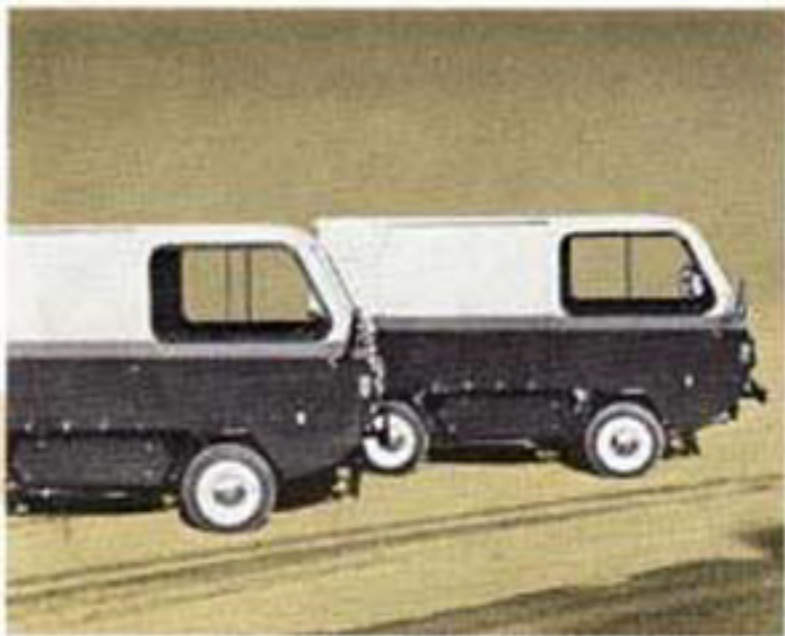

UTILITY VEHICLES AND EQUIPMENT

Are you responsible for vehicles that must deliver mail? . . . Inspect railroad track or high tension lines? . . . Transport farm materials? If so, look into Salsbury's "hands off" type automatic drive. It provides approximately a 3:1 "low gear" ratio up to a 1:1 or overdrive "high gear" — without shifting, without clutching, but always operating at optimum engine-to-drive wheel relationship.



ALL-TERRAIN VEHICLES

These "go-anywhere, do-anything" fun (and work) vehicles are taking the country by storm! To move these hardy ATV's through water or over rugged terrain, the majority of ATV manufacturers now incorporate Salsbury automatic torque converters. Smooth, controlled acceleration and deceleration to the drive wheels precludes tire spin-out or loss of traction. OEM designers, faced with small engine compartments, greatly favor the compact dimensions and automatic operation of Salsbury drives.



How It's Applied:

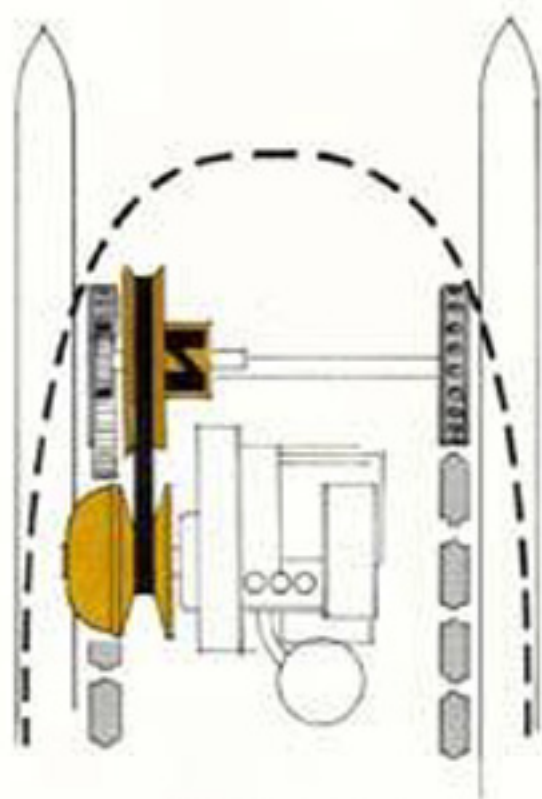

SNOWMOBILE

Typical hook-up through belt or chain to dual sprocket track drive.

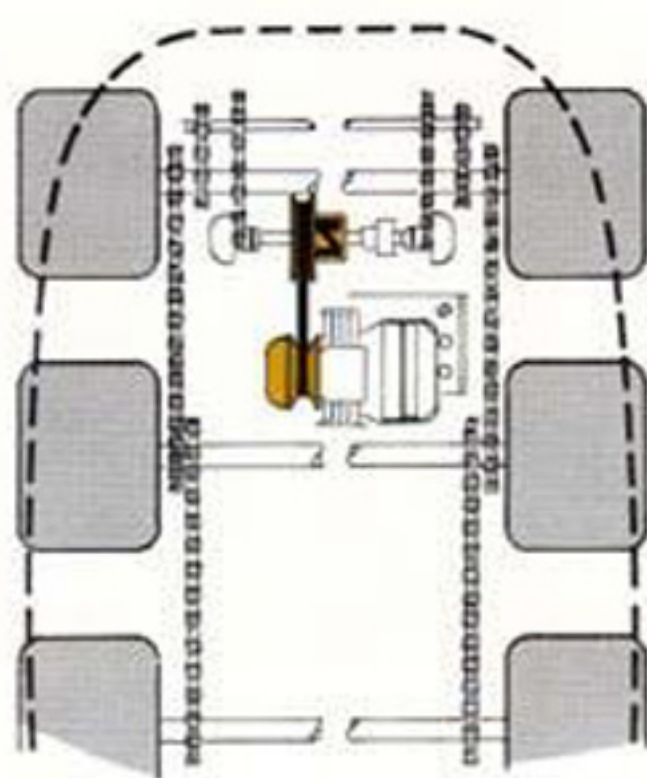

ALL-TERRAIN VEHICLE

Shows typical 6-wheel chain drive with dual clutches for tank-type steering.

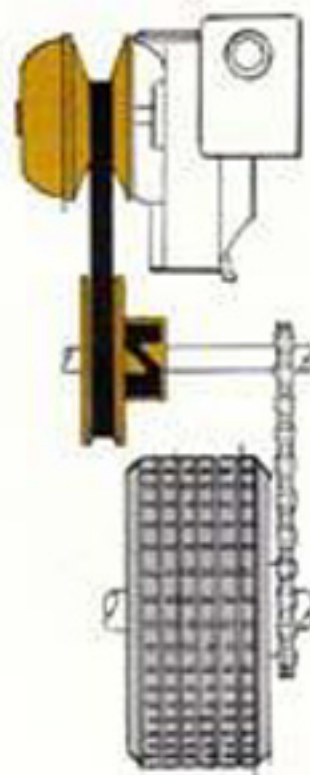

MINI-BIKE OR VEHICLE

Use of jack-shaft to transmit variable ratio to drive wheel(s).

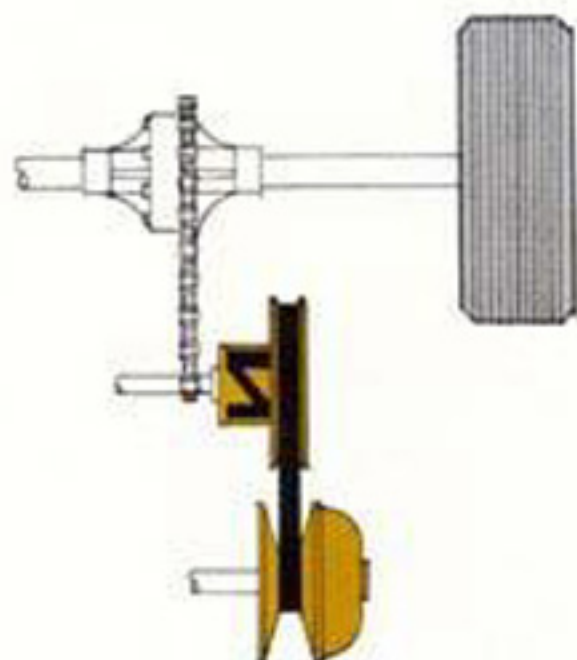

Chain drive through differential.

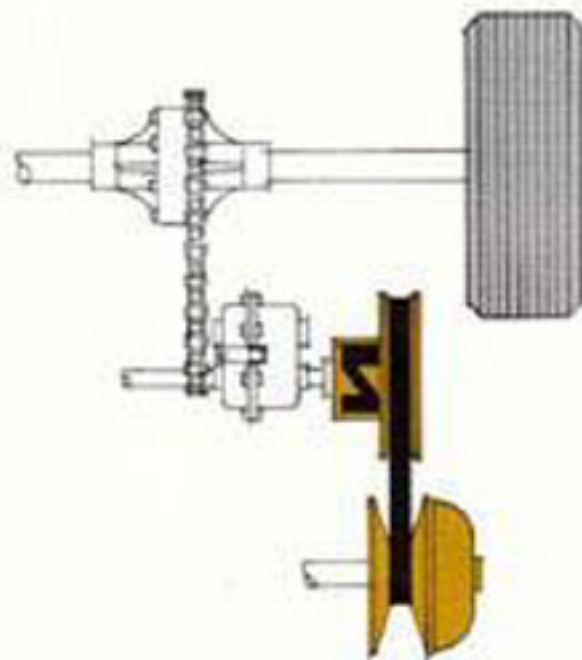

Chain drive through differential with reverse gear box.

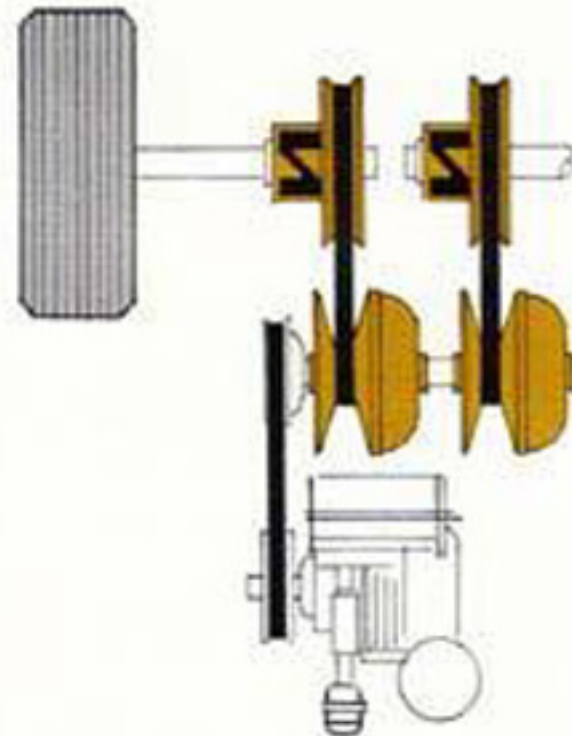

Dual torque converter to individual drive wheels — no differential required.

Net Horsepower Required

It is of utmost importance that the torque converter selected have adequate capacity to transmit all the power required to propel the vehicle; however for the torque converter to function most efficiently, it is extremely important that the engine selected have ample capacity to propel the vehicle at desired speeds over the required terrain and grades.

Net horsepower is the actual horsepower required to propel the vehicle at desired MPH under actual operating conditions and is not to be confused with the rated horsepower of the engine. Net horsepower is the rated horsepower of the engine less (1) friction loss in the power train from engine to drive wheel, (2) any losses due to altitude, (3) air intake temperature, (4) power required to drive accessory equipment, or losses due to restrictions caused by (5) intake silencers or (6) special mufflers.

Allowing for 85% overall efficiency of power train from engine to drive wheel, the net horsepower required to propel a rubber-tired vehicle can be determined by the following formula:

$$\text{Net HP} = \frac{3.14 \times \text{MPH} \times \text{TE}}{1000}$$

where: MPH is desired speed in "high"

TE (tractive effort expressed in pounds at drive wheel) = RR + GR + AR

where: RR is rolling resistance in pounds:

25¢ per 1000¢ GVW on smooth concrete

30¢ per 1000¢ GVW on firm turf

100¢ per 1000¢ GVW on sand
(GVW is gross weight of vehicle)

GR is grade resistance in pounds:

.01 x GVW x % grade (numerical, not decimal)

(% grade is percentage of rise in proportion to distance forward on a straight line. Note: Percentage does not mean degree of grade; a 45° slope is a 100% grade.)

AR is air resistance in pounds:

.0025 x MPH² x FA

(FA is frontal area of vehicle in square feet)

How It Performs:

TYPICAL SHIFTING CHARACTERISTICS

Shifting characteristics of the Salsbury Automatic Drive during acceleration are essentially the same for both the speed sensitive and the torque sensitive types. Shifting is extremely smooth with no "steps" during ratio changes. Note that loading of the vehicle is a factor in shifting time. Heavy vehicle loads are compensated by partial drive shift to lower ratio for maximum torque multiplication.

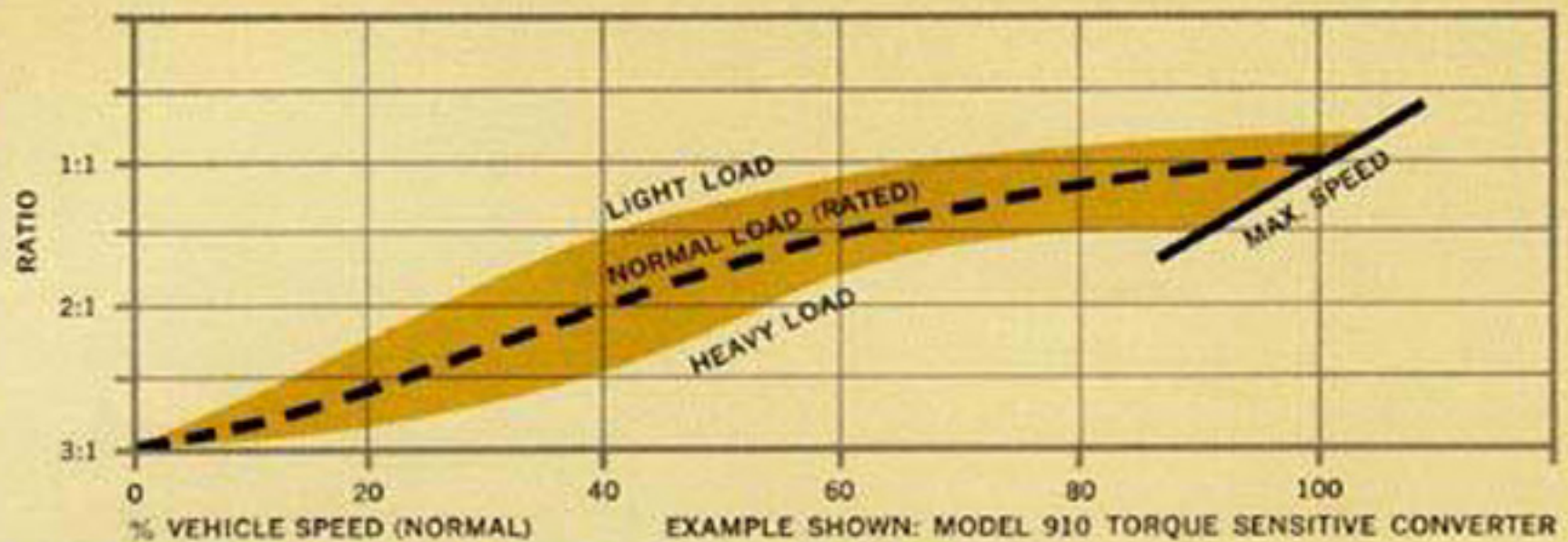

TYPICAL PERFORMANCE CURVES

The curves at right are intended to depict acceleration performance only under a given condition. The example shown is performance during acceleration of a 500 lb. vehicle operating on a smooth, hard surface. It is powered by a 15 h.p., 2-cycle engine with a Model 780 torque sensitive Salsbury automatic drive. Note that the engine accelerates to maximum horsepower within two seconds' time.

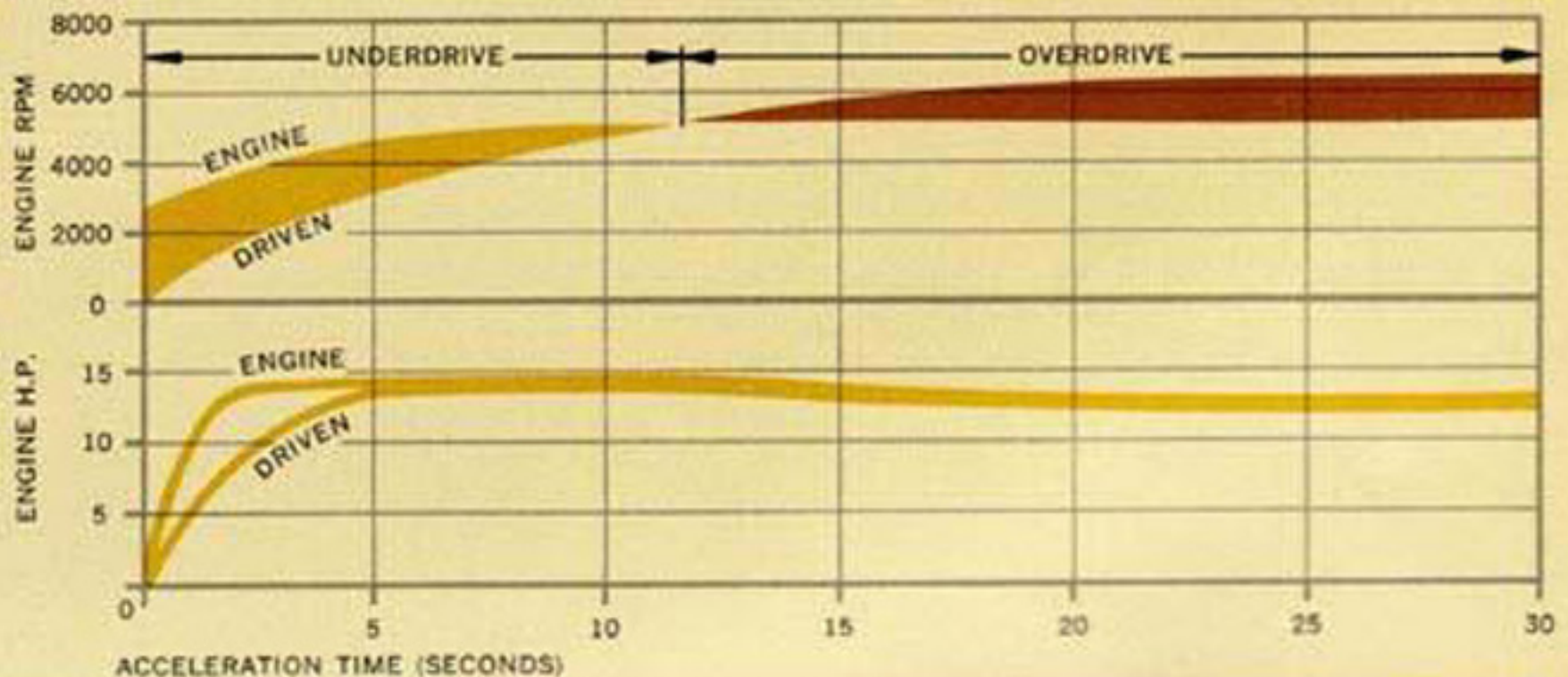

Engine Rated Horsepower and Total Ratio

Engine manufacturers usually rate their engines "corrected" to sea level, at 60° F, intake air temperature and less starter-generator, special intake silencers or other accessories. They also recommend that for intermittent duty and variable loads, that maximum load should not exceed 85% of rated horsepower. As a result, there is usually a considerable difference between rated h.p. and actual net h.p. delivered to the drive wheel. Using the formula below, select an engine with a net h.p. equal to or greater than the net h.p. determined under "NET HORSEPOWER REQUIRED":

Net HP = (Rated HP @ operating RPM x .85) x AF x TF x AL
 where: AF is altitude factor (3% rated HP per 1000' above sea level)
 TF is temperature factor — air intake (1% rated HP for each 10° above 60° F.)
 AL is accessory loss — 4-cycle engines only (1 HP for starter-generator; .5 HP for intake-silencer)

RATIO — ENGINE TO DRIVE WHEEL

First, determine RPM of drive wheel at desired MPH and drive wheel diameter:

$$\text{RPM of drive wheel} = 168.4 \times \frac{\text{MPH}}{r}$$

where: r is rolling radius of drive wheel in inches (less depression of tire due to load)

Next, determine engine operating speed, taking into consideration the manufacturer's recommendations regarding duty (intermittent or continuous), loading, ventilation, etc.

$$\text{TR} = \frac{\text{RPM - engine}}{\text{RPM - drive wheel}}$$

where: TR is total or overall speed ratio from engine to drive wheel.

Usually, total ratio is obtained through two or more steps or reductions as shown in the sketches on page 8. To determine total ratio from engine to rear drive wheel, multiply the ratio of the first step by the second, that total by the third step, etc. For example, with a Salsbury converter at a 1:1 ratio (in "high gear") between the engine and jack shaft, with a 15-tooth sprocket on the jack shaft and a 45-tooth sprocket on the differential shaft (3:1 ratio), and with a 5:1 reduction differential; the total ratio (TR) would be determined as follows:

$$\frac{1}{1} \times \frac{3}{1} \times \frac{5}{1} = \frac{15}{1} \text{ or } 15:1 \text{ TR (total ratio)}$$

How It's Selected:

2-CYCLE ENGINES

Salsbury offers a wide range of converter ratings for both 2-cycle and 4-cycle engines. Shown at right are the models available for the higher-RPM operation of 2-cycle engines, from 3 up to 85 h.p. For 2-cycle operation, Salsbury drives have the following speed characteristics:

IDLE SPEED — 2000 RPM
HIGH SPEED — 6000 RPM

When inquiring or ordering, be sure to specify the engine manufacturer and model. Also note any modifications to the stock engine by either the manufacturer or the OEM (original equipment manufacturer).

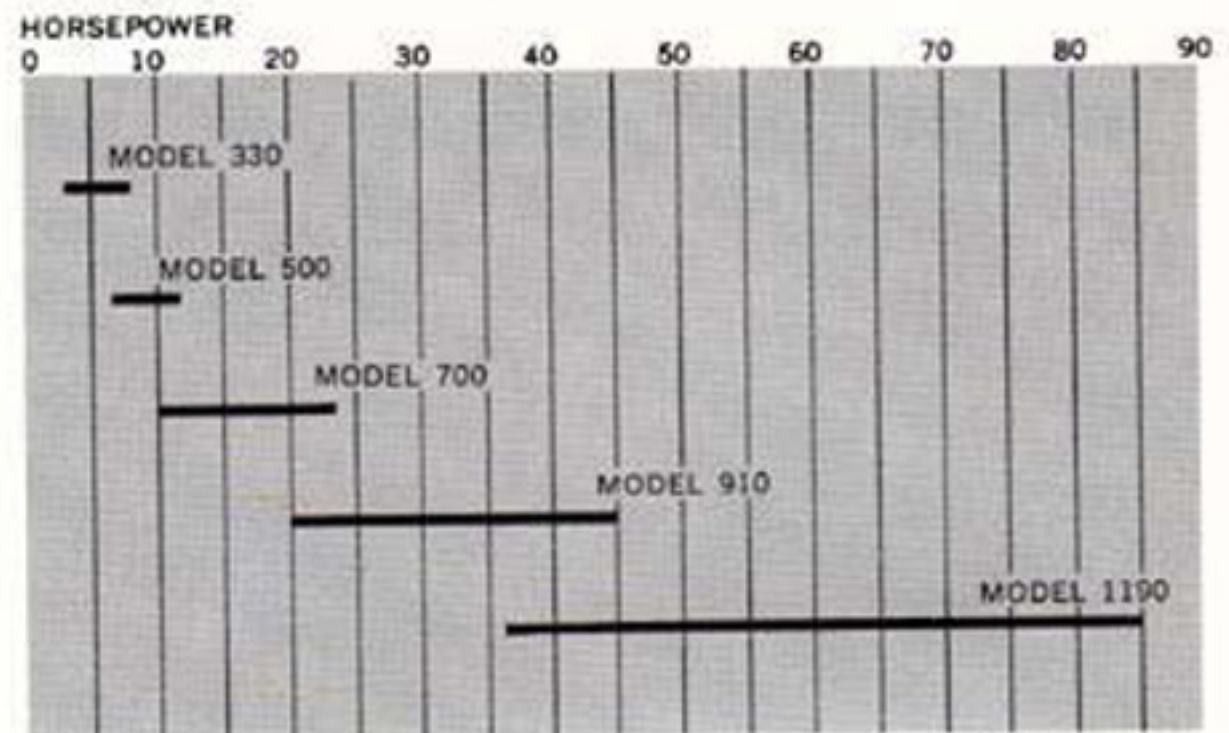

Ratings shown for estimating purposes only. For specific information and recommendations, refer to Engr. Dept.

4-CYCLE ENGINES

Salsbury offers automatic drives for operation with 4-cycle engines in ratings from 2 up to 25 h.p. Note the speed characteristics:

IDLE SPEED — 1400 RPM
HIGH SPEED — 3600 RPM

When inquiring or ordering, be sure to specify the engine manufacturer and model. Also note any modifications to the stock engine by either the manufacturer or the OEM (original equipment manufacturer).

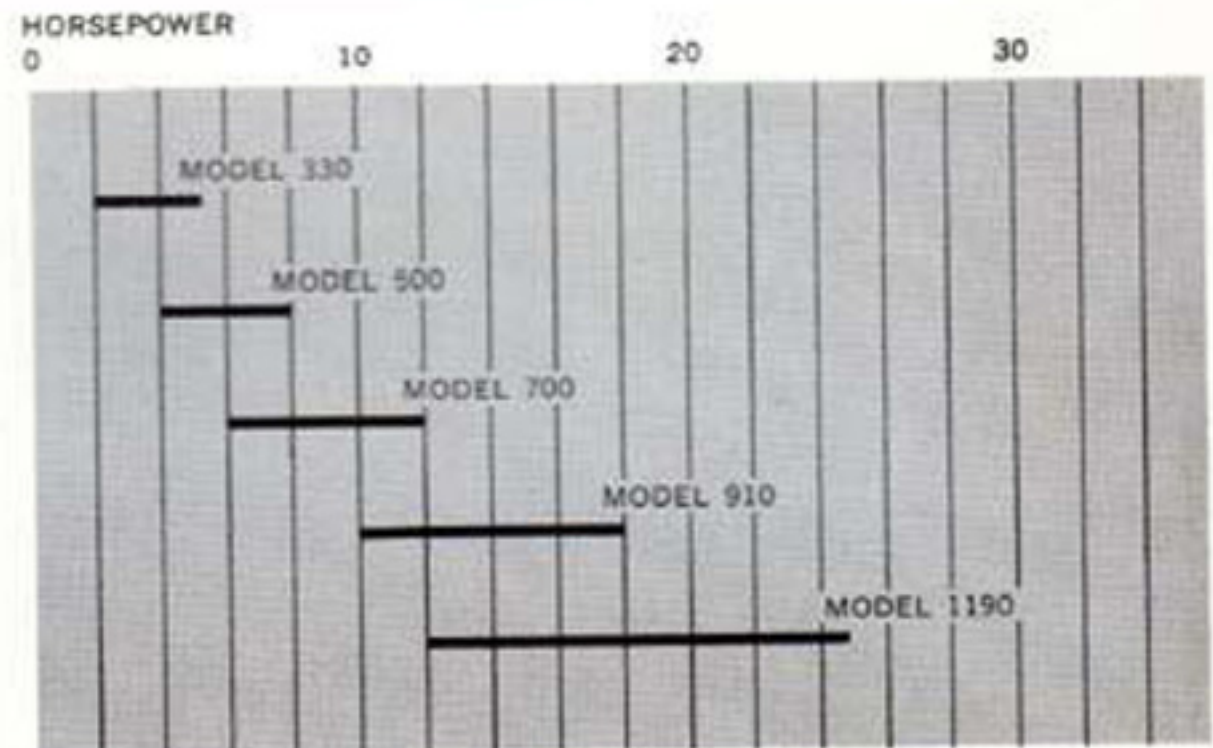

Ratings shown for estimating purposes only. For specific information and recommendations, refer to Engr. Dept.

How It's Sized:

NOTE: Dimensions shown are for estimating purposes only. For Construction purposes, refer to Engr. Dept.

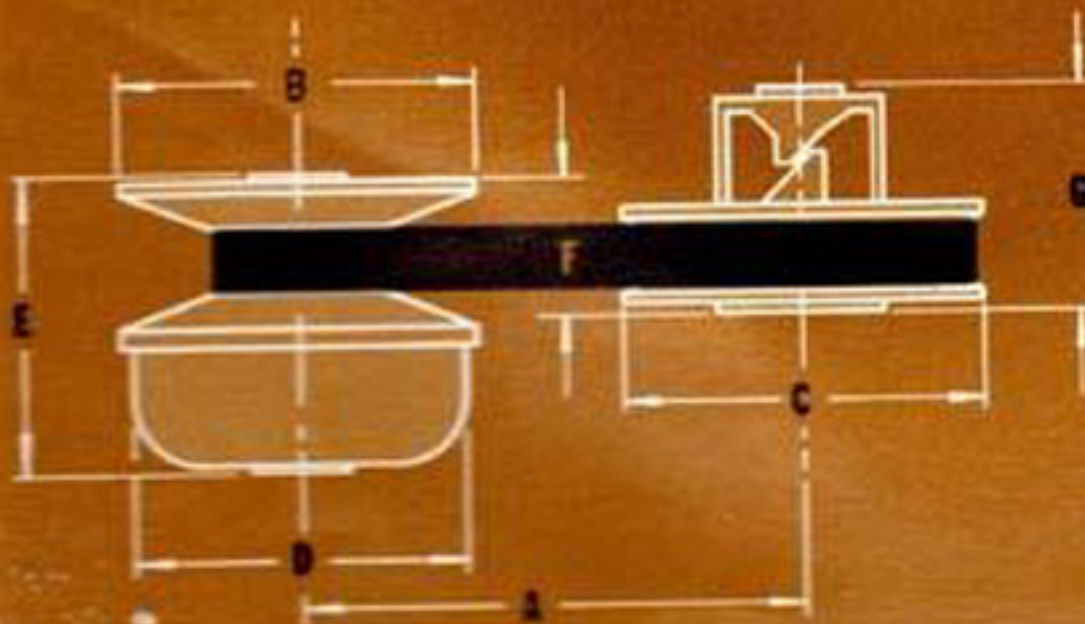

DIMENSIONS (in inches)

MODEL NO.	TYPE (1)	A		B	C	D	E	F	G
		MIN. (2)	MAX. (2)						
330	TS	7	13	4.5	6.06	5.16	3.31	1.22	3.12
500	SS	7	14.26	5.38	7.46	6.21	4.5	1.82	3.82
700	SS TS	10.25	13	7.22	9.84	6.21	4.79	1.82	4.14
770, 775	SS	9.28	17.18	7.22	9.84	6.21	4.79	2	3.99
770	TS	9.42	17.18	7.22	9.84	6.21	4.79	2.14	4.32
780	TS	9.5	17.95	7.22	9.25	6.21	4.79	2.1	4.32
790, 795	SS	9.12	18.36	7.22	8.46	6.21	4.79	2.04	4.01
790	TS	9.12	18.36	7.22	8.46	6.21	4.79	2.04	4.5
910	TS	10.18	12.50	7.7	9.84	7.10	5.54	2.26	4.56
1190	TS	10.18	16.5	8	9.84	8.3	5.91	2.45	4.66
1195	SS	10.18	16.5	8	9.84	8.3	5.91	2.45	4.10

(1) Torque sensitive or speed sensitive.
(2) Available as standard with optional sizes between max. and min.; for exceptional requirements, refer to Engr. Dept.

How It's Quality Controlled:



Production test of Salsbury converter driver pulley.

A reputation for quality manufacturing can be achieved only after years of faithful adherence to these basic principles: Excellence in product design and engineering, exacting production techniques for product uniformity, and rigorous quality control procedures!

PRODUCTION TEST ENSURES PRODUCT RELIABILITY

At Salsbury Corporation, the assembled drives are mounted on a test-stand for comprehensive examination. This production test, which takes place prior to shipment, subjects the drive to speeds and loads in excess of its given ratings. Providing high reliability in field operation, this test is just another way in which Salsbury maintains its reputation as the nation's leading manufacturer of automatic torque converters for sports and utility vehicles.



Len Robbins, left, Vice-President of Manufacturing and Engineering, and Dennis Mallon, Vice-President of Sales, discuss test results in experimental laboratory at Salsbury.

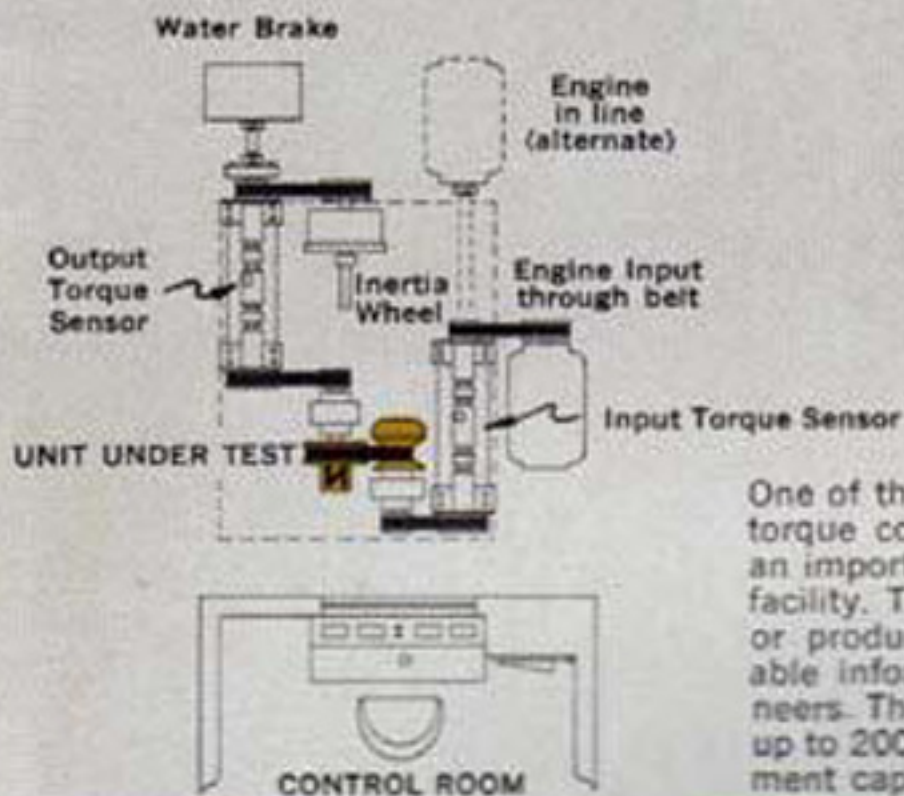

View of snowmobile converter being tested in laboratory at Salsbury Plant.

UNIQUE TEST LABORATORY PROVES PRODUCT DESIGN

One of the most complex laboratories for testing torque converters and clutches in the nation is an important part of the Salsbury manufacturing facility. This test lab is used to check prototype or production units completely, providing valuable information to the team of Salsbury engineers. The facility has capability to check engines up to 200 h.p. with readout torque sensing equipment capable of 5000 inch-pounds.



Operational Safety

Any device that rotates at high speeds and consists of separate and/or loose rotating parts presents a possible hazard; it is, therefore, wise to take precautionary measures of protection against damage or casualty. While each Salsbury unit has been checked before shipment, there are numerous factors beyond our control which we suggest be inspected before use or exercised after installation:

- Damage in shipment causing fractures or out of balance conditions.
- Parts damaged through improper installation procedures.
- Wobble in customer's engine or jack shaft causing out of balance vibration.
- Excessive wear caused by improper lubrication.
- Deterioration of parts from rust, corrosion, or service over extended periods beyond normal life of the unit.
- Introduction of stones, sticks or other foreign objects into the converter mechanism, subjecting parts to undue strain.
- Overspeeding on higher rated engines or on down grades, thus causing converter to operate at excessive speeds.

Preventative Maintenance

The following simple service functions should be performed at the intervals noted:

100-hour intervals:

- Check engine hold-down bolts, pillow block bolts, etc., which may affect proper belt alignment.
- If vehicle has operated in dusty or adverse conditions, disassemble pulley and clean thoroughly with solvent. Apply a light coat of penetrating oil to all pins and pulley hub surface.

250-hour intervals:

- Remove and disassemble both pulleys. Inspect springs, pivot pins, bearing surfaces and replace all parts that appear to be worn.
- Lubricate bearing surfaces with light weight oil. (Pulley flanges and V-belt should be kept free of oil and grease.)
- Inspect belt for uneven wear. If belt shows excessive or uneven wear, check (1) alignment of components and (2) engine idling speed.

CAUTION: Never accelerate engine beyond idling speed with the brake set.



SALSBUURY
CORPORATION

1010 EAST 62nd ST., LOS ANGELES, CALIFORNIA 90001 • PHONE (213) 232-6181

A DIVISION OF **ISIC** INSTRUMENT SYSTEMS CORPORATION