



Tecumseh

engine
specification
catalog

EFFECTIVE OCTOBER 1, 1987



TECUMSEH PRODUCTS COMPANY
ENGINE AND TRANSMISSION
GROUP SERVICE DIVISION
GRAFTON, WI 53024 (414) 377-2700

3 HORSEPOWER (SMALL FRAME) TILLER APPLICATION

STANDARD EQUIPMENT & DIMENSIONS

MODEL	H30
HORSEPOWER	3.0 2.24 kW
BORE & STROKE	2-1/2 x 1-27/32
INCHES	
MILLIMETERS	63.51 x 46.84
DISPLACEMENT	9.06
CUBIC INCHES	
CUBIC CENTIMETERS	148.00
LUBRICATION	Splash
GOVERNOR	Mechanical
OIL CAPACITY	21
OUNCES	
LITERS	.62
NET WEIGHT (APPROX.)	25.00
POUNDS	
KILOGRAMS	11.34
BOLT MTG. CIRCLE (IN INCHES)	3-5/8

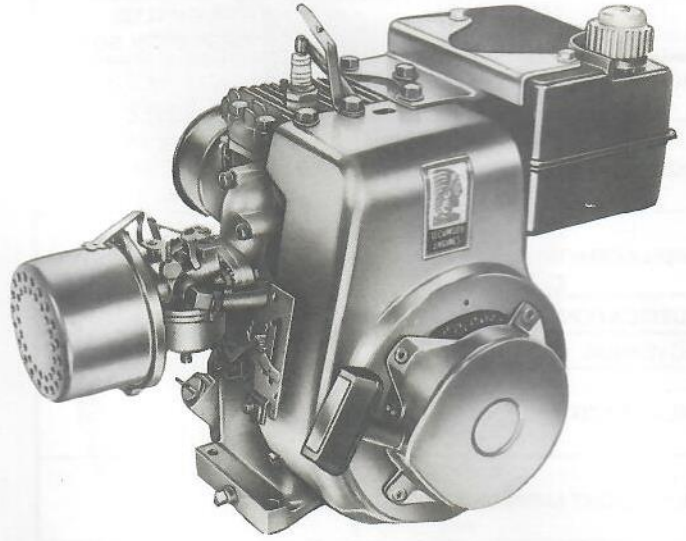

ENGINE VARIATIONS (CRANKSHAFT SPECIFICATIONS MAY VARY ON O.E.M. ENGINES)

SERVICE NUMBER	CRANKSHAFT NUMBER	AUXILIARY P.T.O. SHAFT	EXHAUST DIRECTION	CAPACITY IN QUARTS	FUEL TANK	PULSE TYPE FUEL PUMP	CARBURETOR	CONTROLS	BALL BEARING	STARTER	MAGNETO FEATURE	REGULATOR	AIR CLEANER	OIL FILLER TUBE	OIL DRAIN	CAST IRON BORE	BOLT MTG. CIRCLE - SEE NOTES	FAST MOVING ENGINES	
SERIES 902000 (HORIZONTAL 3.0 H.P.)																			
902605	34725	PS	2				FI	M	X	Re	SS		P	DS				STD ■	✓
902660	34756	PS	2				FI	M		Re	SS		P	DS				GW ‡	

NOTE: Length of crankshaft is measured from drilled and tapped face on the cover plate to end of shaft.

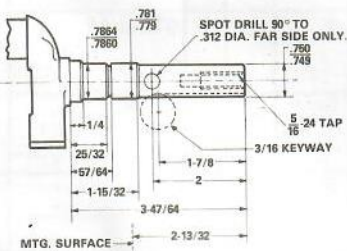

34725

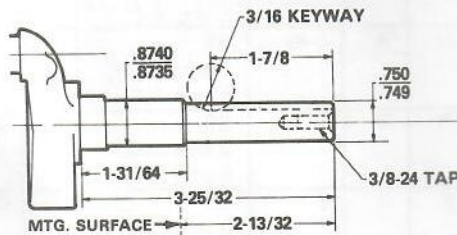

34756

NOTES

DS Dual sides oil drain
FI Float carburetor
GW Garden Way
M Manual control

P Paper air cleaner
PS P.T.O. side
Re Rewind starter
SS Solid State

STD Standard Engine
■ This engine is not eligible for return.
‡ This engine is not eligible for after-market O.E.M. Discount.

3.5 HORSEPOWER (SMALL FRAME) INDUSTRIAL APPLICATION XL XTRA LIFE INDUSTRIAL/COMMERCIAL

STANDARD EQUIPMENT & DIMENSIONS

MODEL		HXL35
HORSEPOWER		3.5 2.61 kW
BORE & STROKE	INCHES	2-1/2 x 1-15/16
	MILLIMETERS	63.51 x 49.23
DISPLACEMENT	CUBIC INCHES	9.52
	CUBIC CENTIMETERS	156.00
LUBRICATION		Splash
GOVERNOR		Mechanical
OIL CAPACITY	OUNCES	21
	LITERS	.62
NET WEIGHT (APPROX.)	POUNDS	26.75
	KILOGRAMS	12.13
BOLT MTG. CIRCLE (IN INCHES)		3-5/8

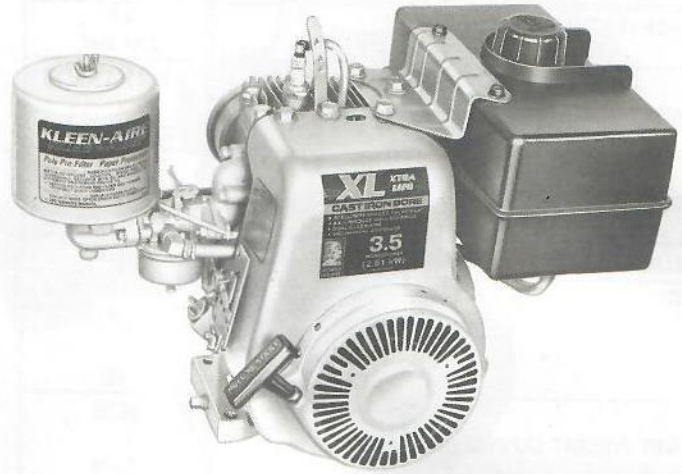

ENGINE VARIATIONS (CRANKSHAFT SPECIFICATIONS MAY VARY ON O.E.M. ENGINES)

SERVICE NUMBER	CRANKSHAFT NUMBER	AUXILIARY P.T.O. SHAFT	EXHAUST DIRECTION	CAPACITY IN QUARTS	FUEL TANK	PULSE TYPE FUEL PUMP	CARBURETOR	CONTROLS	BALL BEARING	STARTER	MAGNETO FEATURE	REGULATOR	AIR CLEANER	OIL FILLER TUBE	OIL DRAIN	CAST IRON BORE	BOLT MTG. CIRCLE - SEE NOTES	FAST MOVING ENGINES - SEE NOTES	
SERIES 903000 (HORIZONTAL 3.5 H.P.)																			
903230A	35121		PS	4			FI	M	X	Re	SS		DE		DS		X	STD ■ AS	✓

NOTE: Length of crankshaft is measured from drilled and tapped face on the cover plate to end of shaft.

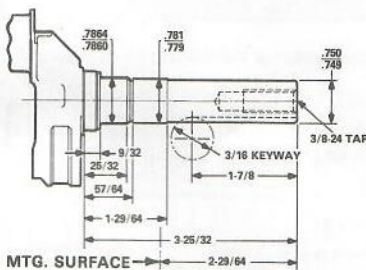

35121

NOTES

AS American Special
DE Dual element air cleaner
DS Dual sides oil drain
FI Float carburetor

M Manual control
PS P.T.O. side
Re Rewind starter

SS Solid State
STD Standard Engine
■ This engine is not eligible for return.

3.5 HORSEPOWER (SMALL FRAME) MINI BIKE APPLICATION

STANDARD EQUIPMENT & DIMENSIONS

MODEL		H35
HORSEPOWER		3.5 2.61 kW
BORE & STROKE	INCHES	2-1/2 x 1-15/16
	MILLIMETERS	63.51 x 49.23
DISPLACEMENT	CUBIC INCHES	9.52
	CUBIC CENTIMETERS	156.00
LUBRICATION		Splash
GOVERNOR		Mechanical
OIL CAPACITY	OUNCES	21
	LITERS	.62
NET WEIGHT (APPROX.)	POUNDS	25.00
	KILOGRAMS	11.34
BOLT MTG. CIRCLE (IN INCHES)		3-5/8

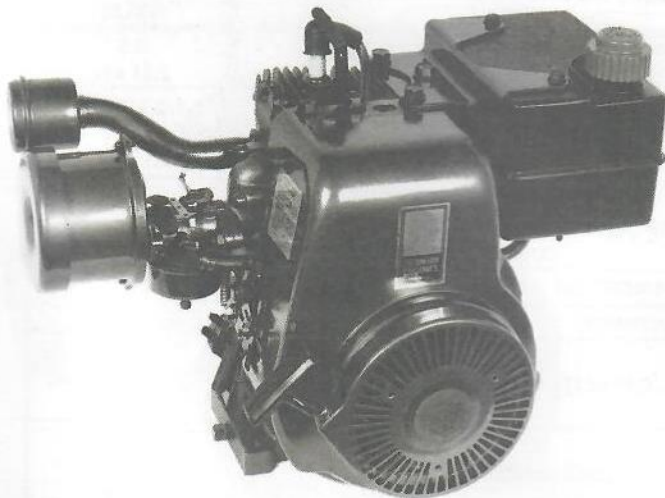

ENGINE VARIATIONS (CRANKSHAFT SPECIFICATIONS MAY VARY ON O.E.M. ENGINES)

AUXILIARY P.T.O. SHAFT	EXHAUST DIRECTION	CAPACITY IN QUARTS	FUEL TANK	PULSE TYPE FUEL PUMP	CARBURETOR	CONTROLS	BALL BEARING	STARTER	MAGNETO FEATURE	REGULATOR	AIR CLEANER	OIL FILLER TUBE	OIL DRAIN	CAST IRON	CAST IRON BORE	BOLT MTG. CIRCLE - SEE NOTES	FAST MOVING ENGINES - SEE NOTES
SERIES 903000 (HORIZONTAL 3.5 H.P.)																	
903440	34736		CS	2		FI	MB	Re	SS		P		DS				STD ■
903450	34734A		CS	2		FI	MB	Re	SS		P		DS				STD ■

NOTE: Length of crankshaft is measured from drilled and tapped face on the cover plate to end of shaft.

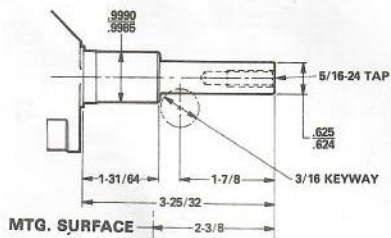

34736

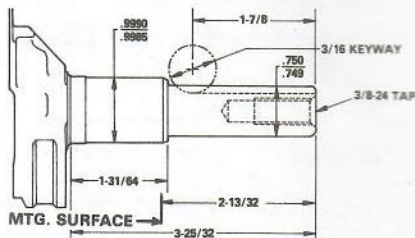

34734A

NOTES

CS Carburetor side
DS Dual sides oil drain
FI Float carburetor

MB Mini-Bike control
P Paper air cleaner
Re Rewind starter

SS Solid State
STD Standard Engine
■ This engine is not eligible for return.

3.5 HORSEPOWER (SMALL FRAME) TILLER APPLICATION

STANDARD EQUIPMENT & DIMENSIONS

MODEL	H35
HORSEPOWER	3.5 2.61 kW
BORE & STROKE	2-1/2 x 1-15/16
MILLIMETERS	63.51 x 49.23
DISPLACEMENT	9.51
CUBIC CENTIMETERS	156.00
LUBRICATION	Splash
GOVERNOR	Mechanical
OIL CAPACITY	21
LITERS	.62
NET WEIGHT (APPROX.)	25.00
KILOGRAMS	11.34
BOLT MTG. CIRCLE (IN INCHES)	3-5/8

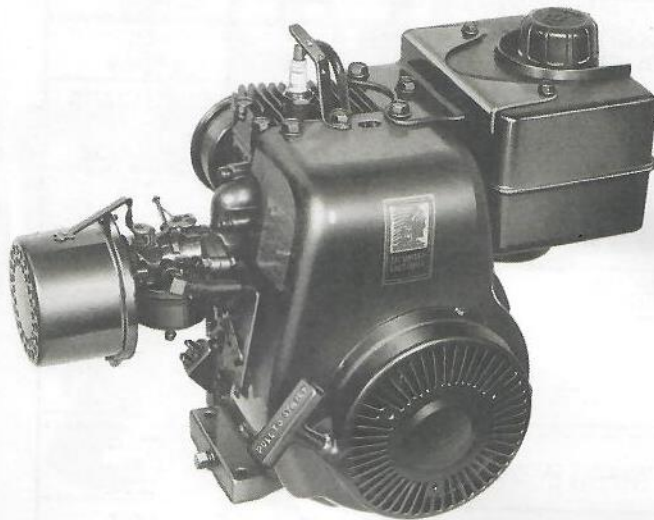

ENGINE VARIATIONS (CRANKSHAFT SPECIFICATIONS MAY VARY ON O.E.M. ENGINES)

SERVICE NUMBER	CRANKSHAFT NUMBER	AUXILIARY P.T.O. SHAFT	EXHAUST DIRECTION	CAPACITY IN QUARTS	FUEL TANK	PULSE TYPE FUEL PUMP	CARBURETOR	CONTROLS	BALL BEARING	STARTER	MAGNETO FEATURE	REGULATOR	AIR CLEANER	OIL FILLER TUBE	OIL DRAIN	BOLT MTG. CIRCLE - SEE NOTES	CAST IRON BORE	CAST IRON	FAST MOVING ENGINES - SEE NOTES	
SERIES 903000 (HORIZONTAL 3.5 H.P.)																				
903609	35132		CS	2			FI	R	X	Re	SS	P		DS					STD	■
903615	35132		PS	2			FI	M	X	Re	SS	P		DS					STD	■
903640	35131		CS	2			FI	M	X	Re	SS	P		DS					STD	■
903663A	34734A	X	PS	2			FI	R		Re	SS	P		DS					GW	‡
903665	35116		PS	4			FI	R	X	Re	SS	F		DS		X			T	‡

NOTE: Length of crankshaft is measured from drilled and tapped face on the cover plate to end of shaft.

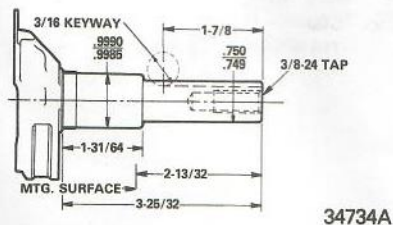
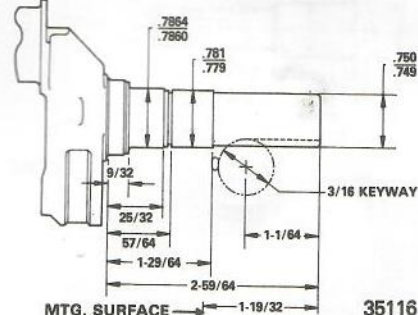
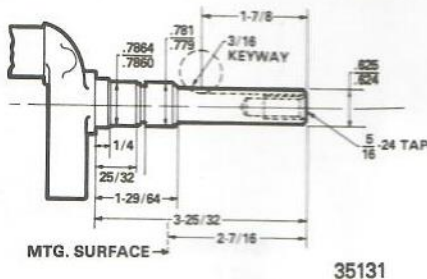
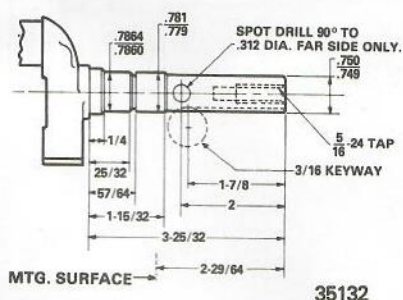

NOTES

CS Carburetor side
 DS Dual sides oil drain
 F Poly foam air cleaner
 FI Float carburetor
 GW Garden Way
 M Manual control
 P Paper air cleaner
 PS P.T.O. side

R Remote control
 Re Rewind starter
 SS Solid State
 STD Standard Engine
 T Toro
 ‡ This engine is not eligible for after-market O.E.M. Discount.
 ■ This engine is not eligible for return.

4 HORSEPOWER (SMALL FRAME) INDUSTRIAL APPLICATION

STANDARD EQUIPMENT & DIMENSIONS

MODEL		HS40
HORSEPOWER		4.0 2.98 kW
BORE & STROKE	INCHES	2-5/8 x 1-15/16
	MILLIMETERS	66.68 x 49.23
DISPLACEMENT	CUBIC INCHES	10.49
	CUBIC CENTIMETERS	171.91
LUBRICATION		Splash
GOVERNOR		Mechanical
OIL CAPACITY	OUNCES	21
	LITERS	.62
NET WEIGHT (APPROX.)	POUNDS	26.75
	KILOGRAMS	12.13
BOLT MTG. CIRCLE (IN INCHES)		3-5/8

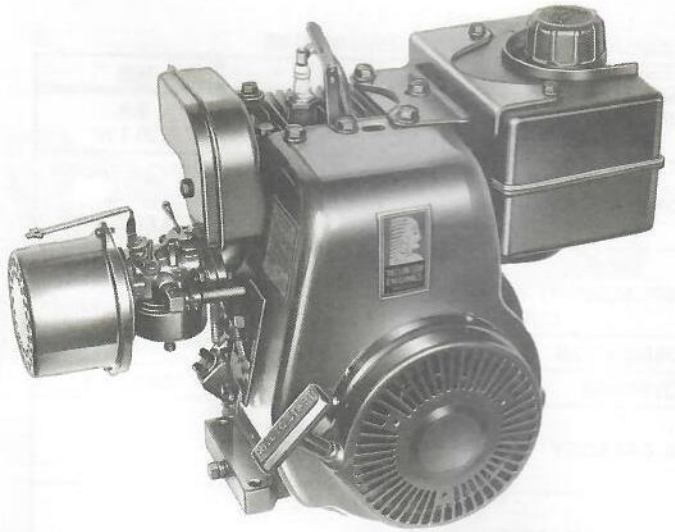

ENGINE VARIATIONS (CRANKSHAFT SPECIFICATIONS MAY VARY ON O.E.M. ENGINES)

CRANKSHAFT SERVICE NUMBER	AUXILIARY P.T.O. SHAFT	EXHAUST DIRECTION	CAPACITY IN QUARTS	FUEL TANK	PULSE TYPE FUEL PUMP	CARBURETOR	CONTROLS	BALL BEARING	STARTER	MAGNETO FEATURE	REGULATOR	AIR CLEANER	OIL FILLER TUBE	OIL DRAIN	CAST IRON BORE	CAST IRON	BOLT MTG. CIRCLE - SEE NOTES	FAST MOVING ENGINES - SEE NOTES	
SERIES 904000 (HORIZONTAL 4.0 H.P.)																			
904210	34734A		CS	2		FI	M		Re		SS	P		DS				STD ■	✓

NOTE: Length of crankshaft is measured from drilled and tapped face on the cover plate to end of shaft.

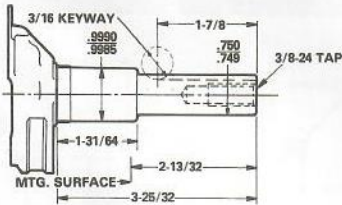

34734A

NOTES

CS Carburetor side
DS Dual sides oil drain
FI Float carburetor

M Manual control
P Paper air cleaner
Re Rewind starter

SS Solid State
STD Standard Engine
■ This engine is not eligible for return.

4 HORSEPOWER (SMALL FRAME) SNOW KING APPLICATION

STANDARD EQUIPMENT & DIMENSIONS

MODEL		HS40
HORSEPOWER		4.0 2.98 kW
BORE & STROKE	INCHES	2-5/8 x 1-15/16
	MILLIMETERS	66.68 x 49.23
DISPLACEMENT	CUBIC INCHES	10.49
	CUBIC CENTIMETERS	171.91
LUBRICATION		Splash
GOVERNOR		Mechanical
OIL CAPACITY	OUNCES	21
	LITERS	.62
NET WEIGHT (APPROX.)	POUNDS	28.00
	KILOGRAMS	12.70
BOLT MTG. CIRCLE (IN INCHES)		3-5/8



ENGINE VARIATIONS (CRANKSHAFT SPECIFICATIONS MAY VARY ON O.E.M. ENGINES)

SERVICE NUMBER	CRANKSHAFT NUMBER	AUXILIARY P.T.O. SHAFT	EXHAUST DIRECTION	CAPACITY IN QUARTS	FUEL TANK	PULSE TYPE FUEL PUMP	CARBURETOR	BALL BEARING	STARTER	MAGNETO FEATURE	REGULATOR	AIR CLEANER	OIL FILLER TUBE	OIL DRAIN	CAST IRON BORE	BOLT MTG. CIRCLE - SEE NOTES	FAST MOVING ENGINES - SEE NOTES
SERIES 904000 (HORIZONTAL 4.0 H.P.)																	
904361	34734A		CS	2			FI	M	Re	RG; SS			X	DS			MTD MW ‡ 5

NOTE: Length of crankshaft is measured from drilled and tapped face on the cover plate to end of shaft.

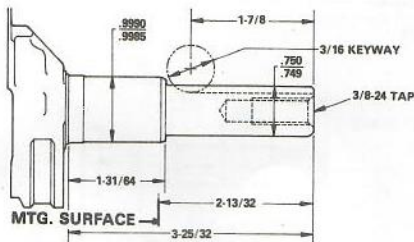

34734A

NOTES

CS Carburetor side
DS Dual sides oil drain
FI Float carburetor
M Manual control
MTD MTD Products Inc.

MW Montgomery Ward
Re Rewind starter
RG Ring gear on flywheel
SS Solid State

‡ This engine is not eligible for after-market O.E.M. Discount.
5 No. 33290C - 120 Volt Electric Starter can be installed.

4 HORSEPOWER (SMALL FRAME) MINI BIKE APPLICATION

STANDARD EQUIPMENT & DIMENSIONS

MODEL		HS40
HORSEPOWER		4.0 2.98 kW
BORE & STROKE	INCHES	2-5/8 x 1-15/16
	MILLIMETERS	66.68 x 49.23
DISPLACEMENT	CUBIC INCHES	10.49
	CUBIC CENTIMETERS	171.91
LUBRICATION		Splash
GOVERNOR		Mechanical
OIL CAPACITY	OUNCES	21
	LITERS	.62
NET WEIGHT (APPROX.)	POUNDS	26.50
	KILOGRAMS	12.02
BOLT MTG. CIRCLE (IN INCHES)		3-5/8

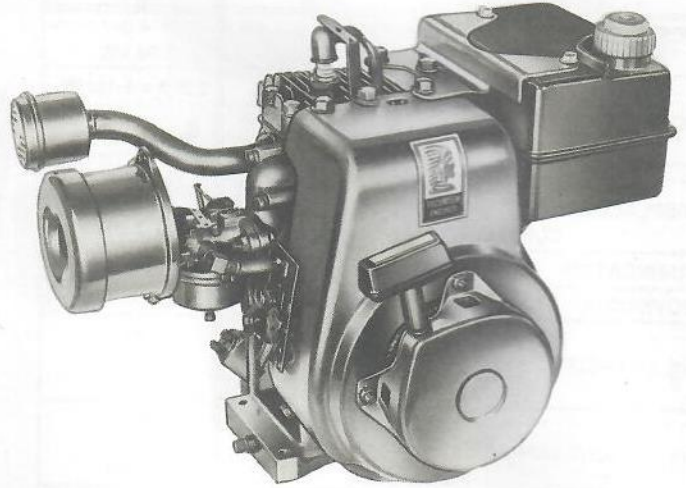

ENGINE VARIATIONS (CRANKSHAFT SPECIFICATIONS MAY VARY ON O.E.M. ENGINES)

SERVICE NUMBER	CRANKSHAFT NUMBER	AUXILIARY P.T.O. SHAFT	EXHAUST DIRECTION	CAPACITY IN QUARTS	FUEL TANK	PULSE TYPE FUEL PUMP	CARBURETOR	CONTROLS	BALL BEARING	STARTER	MAGNETO FEATURE	REGULATOR	AIR CLEANER	OIL FILLER TUBE	OIL DRAIN	CAST IRON	BOLT MTG. CIRCLE - SEE NOTES	SEE NOTES	FAST MOVING ENGINES	
SERIES 904000 (HORIZONTAL 4.0 H.P.)																				
904405	34734A		CS	2			FI	MB		Re	SS			P		DS			STD ■	/
904407	34734A		CS	2			FI	MB		Re	SS; 3 amp			P		DS			STD ■	/
904415	34738		CS				FI	MB	X	Re	SS; 3 amp			P		DS			STD ■ SL	/

NOTE: Length of crankshaft is measured from drilled and tapped face on the cover plate to end of shaft.

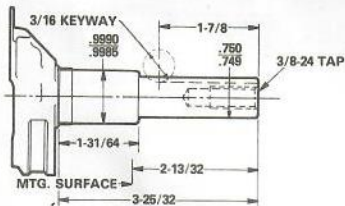

34734A

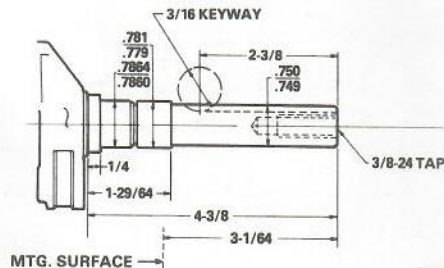

34738

NOTES

CS Carburetor side
DS Dual sides oil drain
FI Float carburetor
MB Mini-Bike control

P Paper air cleaner
Re Rewind starter
SL 20° Slant

SS Solid State
STD Standard Engine
■ This engine is not eligible for return.

5 HORSEPOWER (SMALL FRAME) INDUSTRIAL APPLICATION

STANDARD EQUIPMENT & DIMENSIONS

MODEL		HS50
HORSEPOWER		5.0 3.73 kW
BORE & STROKE	INCHES	2-13/16 x 1-15/16
	MILLIMETERS	71.44 x 49.23
DISPLACEMENT	CUBIC INCHES	12.04
	CUBIC CENTIMETERS	197.34
LUBRICATION		Splash
GOVERNOR		Mechanical
OIL CAPACITY	OUNCES	21
	LITERS	.62
NET WEIGHT (APPROX.)	POUNDS	26.75
	KILOGRAMS	12.13
BOLT MTG. CIRCLE (IN INCHES)		3-5/8

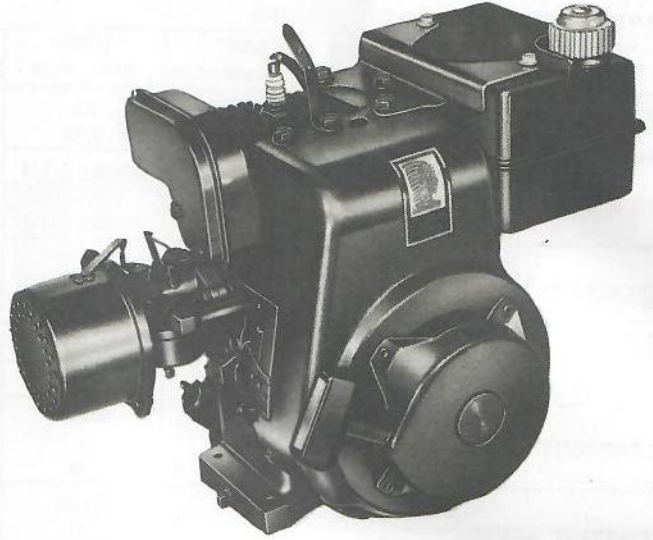

ENGINE VARIATIONS (CRANKSHAFT SPECIFICATIONS MAY VARY ON O.E.M. ENGINES)

SERVICE NUMBER	CRANKSHAFT NUMBER	AUXILIARY P.T.O. SHAFT	EXHAUST DIRECTION	CAPACITY IN QUARTS	FUEL TANK CAPACITY	PULSE TYPE FUEL PUMP	CARBURETOR	CONTROLS	BALL BEARING	STARTER	MAGNETO FEATURE	REGULATOR	AIR CLEANER	OIL FILLER TUBE	OIL DRAIN	CAST IRON CAST IRON BORE	BOLT MTG. CIRCLE - SEE NOTES	FAST MOVING ENGINES - SEE NOTES	
SERIES 905000 (HORIZONTAL 5.0 H.P.)																			
905205	34747		CS	2				FI	M	X	Re	SS		P	DS				STD ■
905215	34744		CS	2				FI	FS	X	Re	SS		P	DS				STD ■

NOTE: Length of crankshaft is measured from drilled and tapped face on the cover plate to end of shaft.

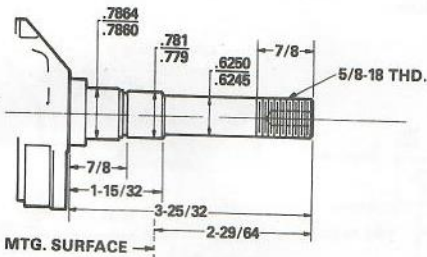

34747

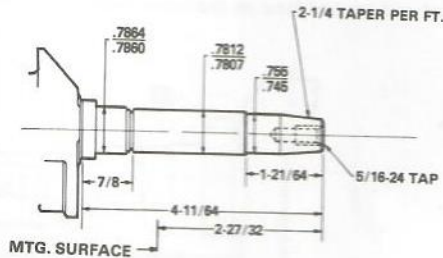

34744

NOTES

CS Carburetor side
DS Dual sides oil drain
FI Float carburetor

FS Fixed speed
M Manual control
P Paper air cleaner

Re Rewind starter
SS Solid State
STD Standard Engine
■ This engine is not eligible for return.

5 HORSEPOWER (MEDIUM FRAME) INDUSTRIAL APPLICATION XL XTRA LIFE INDUSTRIAL/COMMERCIAL

STANDARD EQUIPMENT & DIMENSIONS

MODEL	H50	HH50
	CAST IRON BORE	CAST IRON
HORSEPOWER	5.0 3.73 kW	5.0 3.73
BORE & STROKE	INCHES	2-5/8 x 2-1/4
	MILLIMETERS	66.68 x 57.15
DISPLACEMENT	CUBIC INCHES	12.18
	CUBIC CENTIMETERS	199.57
LUBRICATION	Splash	Splash
GOVERNOR	Mechanical	Mechanical
OIL CAPACITY	OUNCES	19
	LITERS	.56
NET WEIGHT (APPROX.)	POUNDS	37.75
	KILOGRAMS	17.12
BOLT MTG. CIRCLE (IN INCHES)	3-5/8	3-5/8



ENGINE VARIATIONS (CRANKSHAFT SPECIFICATIONS MAY VARY ON O.E.M. ENGINES)

SERVICE NUMBER	CRANKSHAFT NUMBER	AUXILIARY P.T.O. SHAFT	EXHAUST DIRECTION	CAPACITY IN QUARTS	FUEL TANK IN QUARTS	PULSE TYPE FUEL PUMP	CARBURETOR	CONTROLS	BALL BEARING	STARTER	MAGNETO FEATURE	REGULATOR	AIR CLEANER	OIL FILLER TUBE	OIL DRAIN	BOLT MTG. CIRCLE - CAST IRON BORE	CAST IRON	FAST MOVING ENGINES	
SERIES 905000 (HORIZONTAL 5.0 H.P.)																			
905211	34885		CS	4			FI	M	X	Re	RG			DE	DS	X		STD ■ 3	
905225B	35235		CS	4			FI	M	X	Re	SS			DE	X	DS	X	STD ■ AS, 19	✓

NOTE: Length of crankshaft is measured from drilled and tapped face on the cover plate to end of shaft.

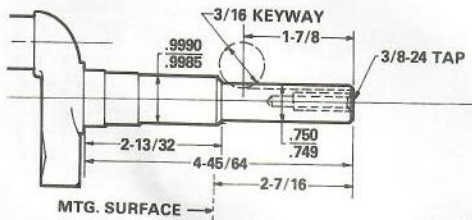

34885

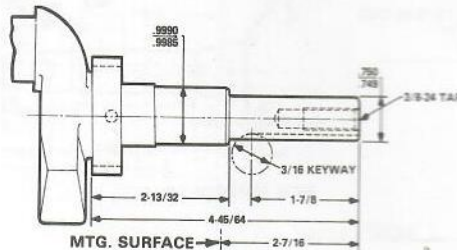

35235

NOTES

- | | | | | | |
|----|--------------------------|-----|---|----|---|
| AS | American Special | Re | Rewind starter | 3 | No. 33328C - 120 Volt Electric Starter can be installed. |
| CS | Carburetor side | RG | Ring gear on flywheel | 19 | No. 33328C - 120 Volt Electric Starter, 611085 flywheel and 32158E blower housing can be installed. |
| DE | Dual element air cleaner | SS | Solid State | | |
| DS | Dual sides oil drain | STD | Standard Engine | | |
| FI | Float carburetor | ■ | This engine is not eligible for return. | | |
| M | Manual control | | | | |

5 HORSEPOWER (SMALL FRAME) SNOW KING APPLICATION

STANDARD EQUIPMENT & DIMENSIONS

MODEL	HS50
HORSEPOWER	5.0 3.73 kW
BORE & STROKE	2-13/16 x 1-15/16
INCHES	
MILLIMETERS	71.44 x 49.23
DISPLACEMENT	12.04
CUBIC INCHES	
CUBIC CENTIMETERS	197.34
LUBRICATION	Splash
GOVERNOR	Mechanical
OIL CAPACITY	21
OUNCES	
LITERS	.62
NET WEIGHT (APPROX.)	28.00
POUNDS	
KILOGRAMS	12.70
BOLT MTG. CIRCLE (IN INCHES)	3-5/8



ENGINE VARIATIONS (CRANKSHAFT SPECIFICATIONS MAY VARY ON O.E.M. ENGINES)

SERVICE NUMBER	CRANKSHAFT NUMBER	AUXILIARY P.T.O. SHAFT	EXHAUST DIRECTION	CAPACITY IN QUARTS	FUEL TANK	PULSE TYPE FUEL PUMP	CARBURETOR	CONTROLS	BALL BEARING	STARTER	MAGNETO FEATURE	REGULATOR	AIR CLEANER	OIL FILLER TUBE	OIL DRAIN	CAST IRON	BOLT MT'G. CIRCLE - SEE NOTES	CAST IRON BORE	FAST MOVING ENGINES	
SERIES 905000 (HORIZONTAL 5.0 H.P.)																				
905305	34740	2:1	CS	2			FI	M		Re	RG			X	DS				STD ■ 5	✓
905310	34740		CS	2			FI	M		Re	RG; SS			X	DS				STD ■ 5	

NOTE: Length of crankshaft is measured from drilled and tapped face on the cover plate to end of shaft.

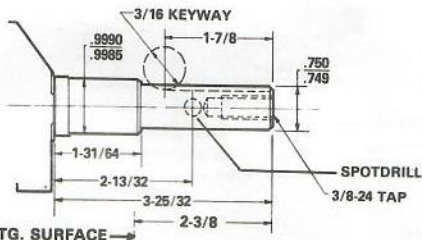

34740

NOTES

CS Carburetor side
DS Dual sides oil drain
FI Float carburetor
M Manual control

Re Rewind Starter
RG Ring gear on flywheel
SS Solid State
STD Standard Engine

■ This engine is not eligible for return.
5 No. 33290C - 120 Volt Electric Starter can be installed.

5 HORSEPOWER (SMALL FRAME) MINI BIKE APPLICATION

STANDARD EQUIPMENT & DIMENSIONS

MODEL		HS50
HORSEPOWER		5.0 3.73 kW
BORE & STROKE	INCHES	2-13/16 x 1-15/16
	MILLIMETERS	71.44 x 49.23
DISPLACEMENT	CUBIC INCHES	12.04
	CUBIC CENTIMETERS	197.34
LUBRICATION		Splash
GOVERNOR		Mechanical
OIL CAPACITY	OUNCES	21
	LITERS	.62
NET WEIGHT (APPROX.)	POUNDS	26.50
	KILOGRAMS	12.02
BOLT MTG. CIRCLE (IN INCHES)		3-5/8

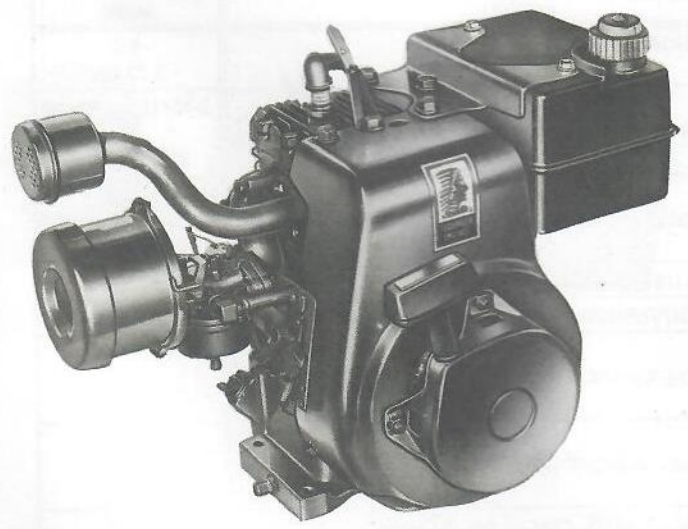

ENGINE VARIATIONS (CRANKSHAFT SPECIFICATIONS MAY VARY ON O.E.M. ENGINES)

SERVICE NUMBER	CRANKSHAFT NUMBER	AUXILIARY P.T.O. SHAFT	EXHAUST DIRECTION	FUEL TANK CAPACITY IN QUARTS	PULSE TYPE FUEL PUMP	CARBURETOR	CONTROLS	BALL BEARING	STARTER	MAGNETO FEATURE	REGULATOR	AIR CLEANER	OIL FILLER TUBE	OIL DRAIN	CAST IRON	BOLT MTG. CIRCLE - SEE NOTES	FAST MOVING ENGINES - SEE NOTES	
SERIES 905000 (HORIZONTAL 5.0 H.P.)																		
905415	34728		CS	2		FI	MB	X	Re	SS		P		DS			STD ■	✓
905425	34728		CS			FI	MB	X	Re	SS; 3 amp		P		DS			STD ■ SL	

NOTE: Length of crankshaft is measured from drilled and tapped face on the cover plate to end of shaft.

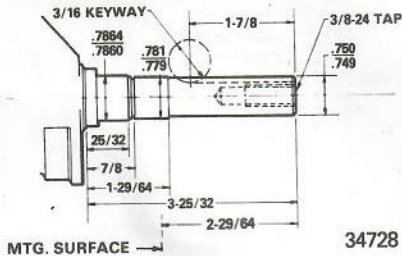

NOTES

CS Carburetor side
DS Dual sides oil drain
FI Float carburetor
MB Mini-Bike control

P Paper air cleaner
Re Rewind starter
SL 20° Slant

SS Solid State
STD Standard Engine
■ This engine is not eligible for return.

5 HORSEPOWER (SMALL FRAME) TILLER APPLICATION

STANDARD EQUIPMENT & DIMENSIONS

MODEL	HS50
HORSEPOWER	5.0 3.73 kW
BORE & STROKE	INCHES 2-13/16 x 1-15/16
	MILLIMETERS 71.44 x 49.23
DISPLACEMENT	CUBIC INCHES 12.04
	CUBIC CENTIMETERS 197.34
LUBRICATION	Splash
GOVERNOR	Mechanical
OIL CAPACITY	OUNCES 21
	LITERS .62
NET WEIGHT (APPROX.)	POUNDS 26.75
	KILOGRAMS 12.13
BOLT MTG. CIRCLE (IN INCHES)	3-5/8

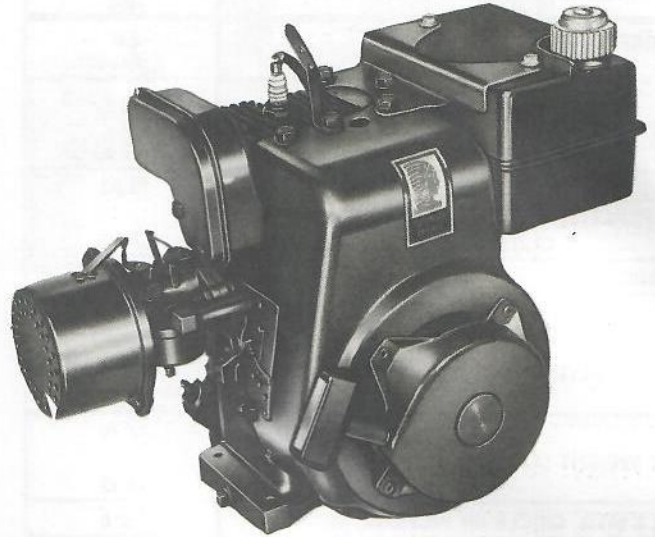

ENGINE VARIATIONS (CRANKSHAFT SPECIFICATIONS MAY VARY ON O.E.M. ENGINES)

SERVICE NUMBER	AUXILIARY P.T.O. SHAFT	CRANKSHAFT NUMBER	EXHAUST DIRECTION	CAPACITY IN QUARTS	FUEL TANK CAPACITY	PULSE TYPE FUEL PUMP	CARBURETOR	CONTROLS	BALL BEARING	STARTER	MAGNETO FEATURE	REGULATOR	AIR CLEANER	OIL FILLER TUBE	OIL DRAIN	CAST IRON BORE	BOLT MT'G. CIRCLE - SEE NOTES	CAST IRON	FAST MOVING ENGINES - SEE NOTES	
SERIES 905000 (HORIZONTAL 5.0 H.P.)																				
905605	34740	2:1	CS	2			FI	R		Re	SS		P		DS				STD ■	✓

NOTE: Length of crankshaft is measured from drilled and tapped face on the cover plate to end of shaft.

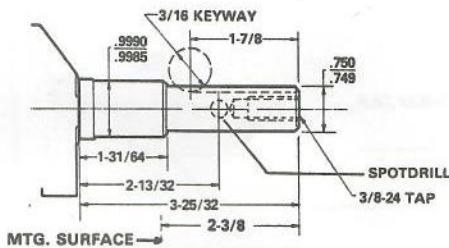

34740

NOTES

CS Carburetor side
DS Dual sides oil drain
FI Float carburetor





P Paper air cleaner
R Remote control
Re Rewind starter

SS Solid State
STD Standard Engine
■ This engine is not eligible for return.

ACCESSORIES

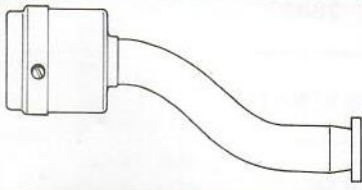
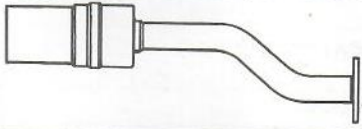
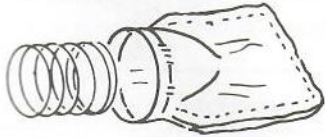
Accessories such as 12 volt and 120 volt electric starters are listed in the "NOTES" column against specific replacement engines. These "NOTES" are explained at the end of the specifications.

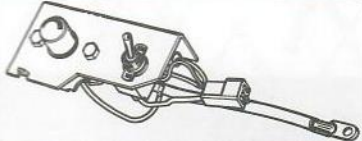
Other accessories which are available are listed as follows:

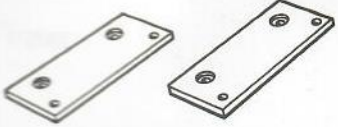
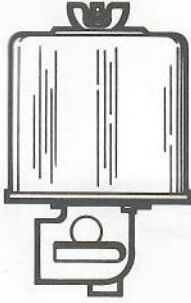
PART NO.	DESCRIPTION	APPLICATION	
33126A 33128A	Muffler, Chrome Spark Arrester Muffler, Chrome Spark Arrester	3.5 H.P. Mini-bike 4 H.P. Mini-bike	
33699	Muffler, Spark Arrester	HS50 Mini-bike	
730512	Pre-cleaner	6 & 7 H.P.	
31573A 32437A	Gauge, Fuel (4.50" long) Gauge, Fuel (5.25" long)		
730198	Panel, Switch	All models with 20 amp system	
34279A	Filter, Fuel	For all engines	
730207	Solid State Conversion Kit	For all models TVS75, TVS90, TVS105, TVS120, TNT100 & TNT120 engines with external magneto ignition.	
730212	Engine Mounting Adaptor (To adapt B & S and Kohler large frame engine mountings)	For all OH120 through OH180 models	
730561	Dual element air cleaner conversion kit	For all H50 through HH70 engines with externally vented, fully adjustable carburetors	

H30

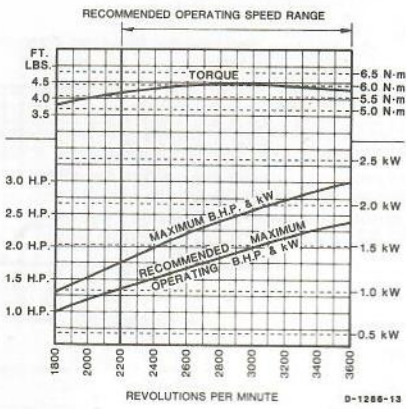

H35; HXL35

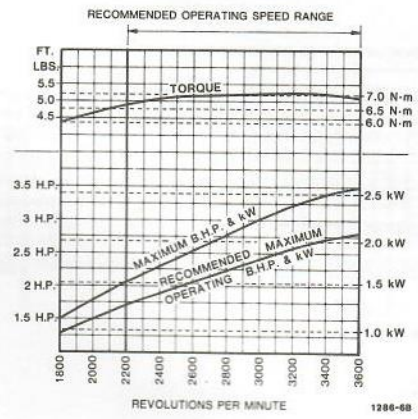

H50

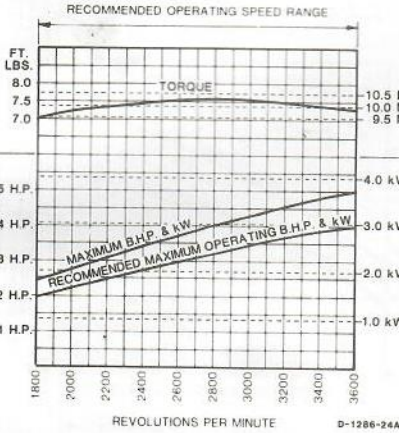

H60

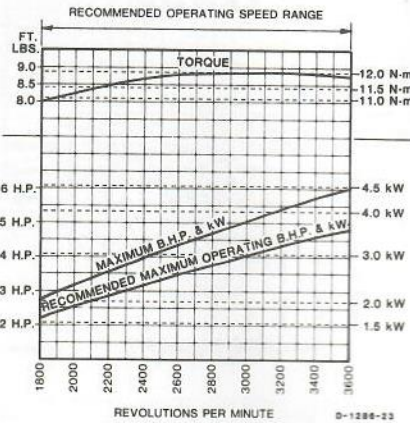

H70

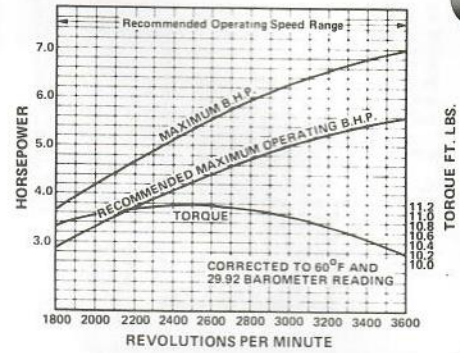

HH50

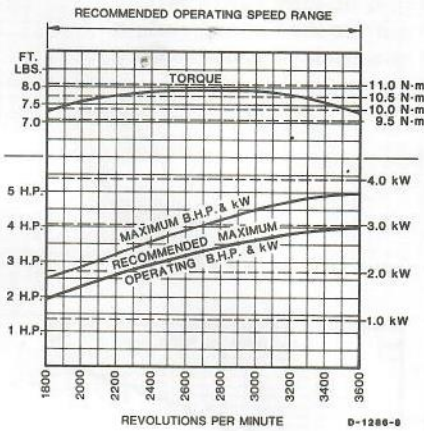

HH60

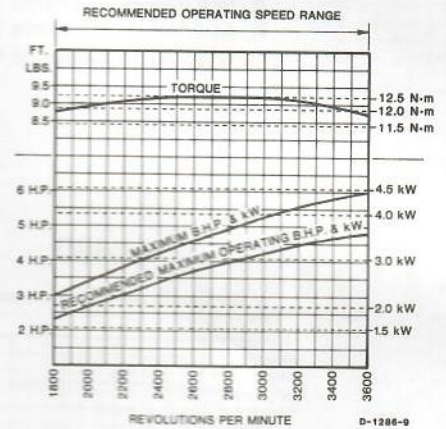

HH70

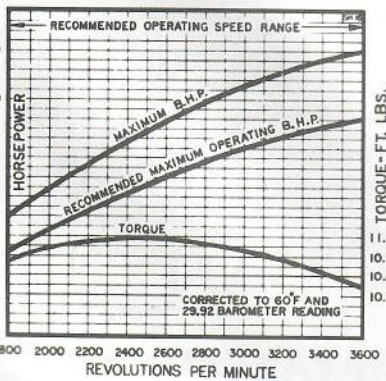

HH100

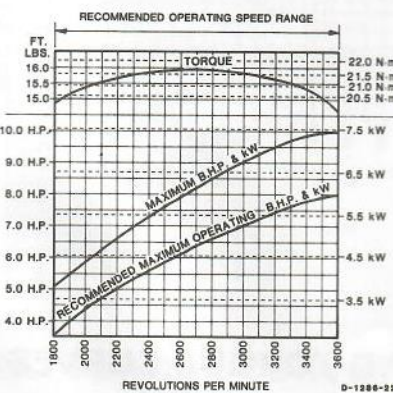

HH120

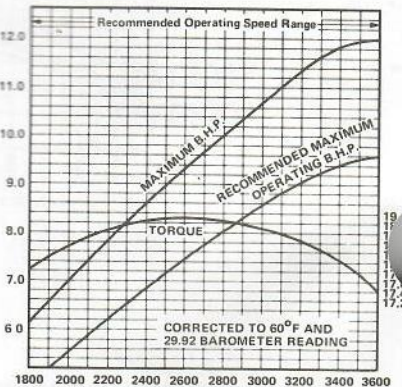

HMXL70

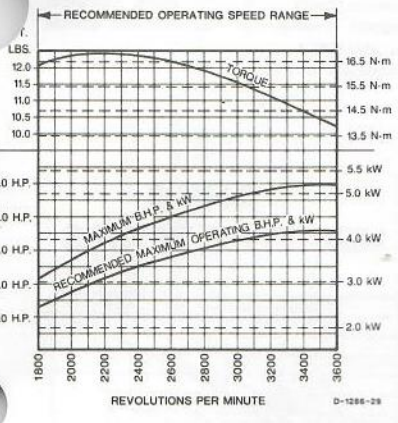

HM80

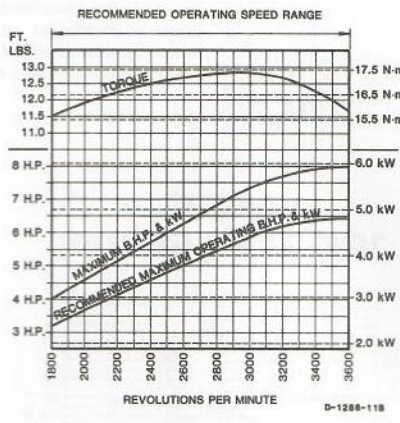

HHM80

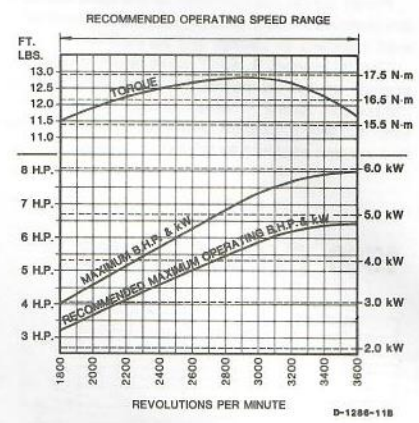

HM100

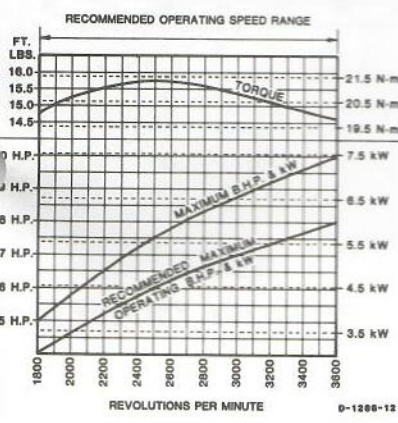

HS40

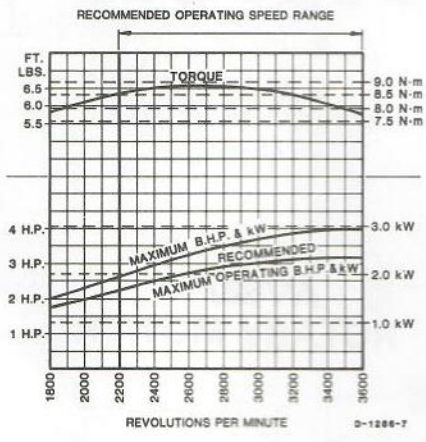

HS50

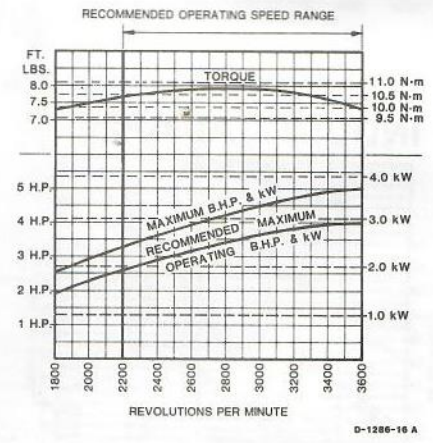

OH120

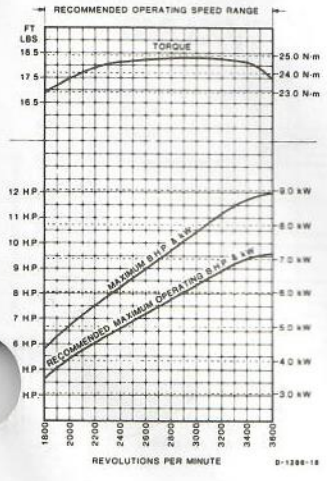

OH160

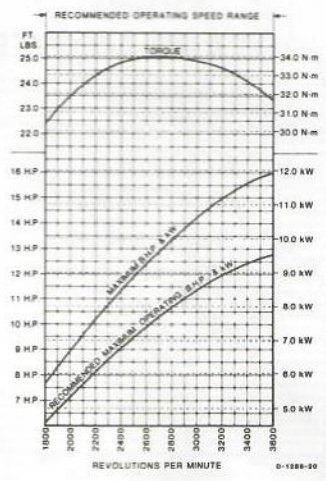

OH180

