

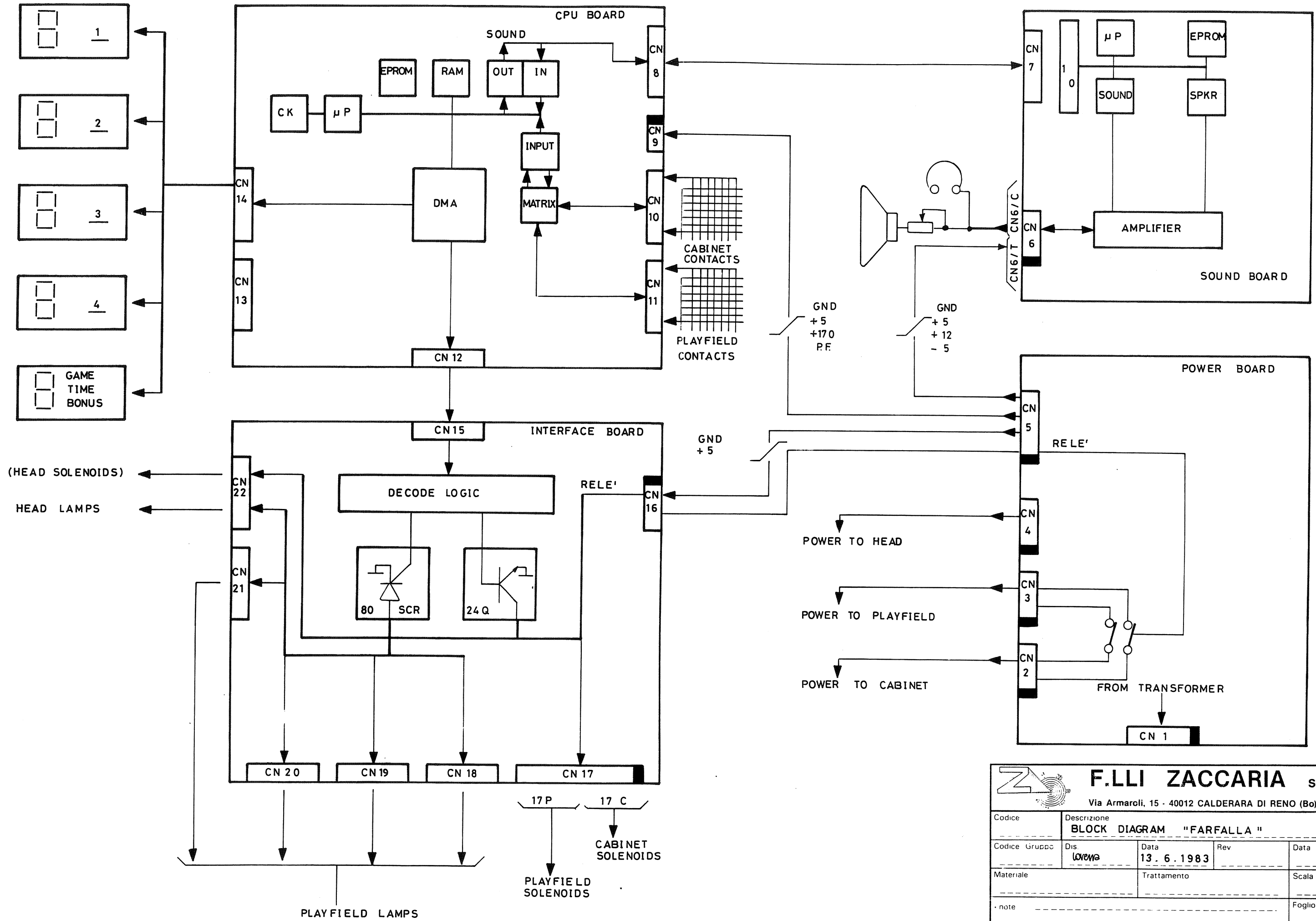

DRIVER DISPLAY BOARDS



 <b>F.LLI ZACCARIA</b> s.n.c. Via Armaroli, 15 - 40012 CALDERARA DI RENO (Bo) ITALY	
Codice	Descrizione
	<b>BLOCK DIAGRAM "FARFALLA"</b>
Codice Gruppo	Dis.
	<i>lorena</i>
Data	Rev
13.6.1983	
Materiale	Trattamento
note	Foglio



a b c d e f g h y k l m n p r s t u v z  
EPROM JUMPERS  
J1 J2 J3 J4 J5 J6 J7 J8 J9 J10 J11 J12

BATTERY CIRCUIT

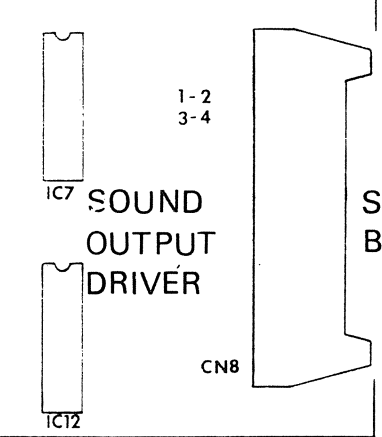
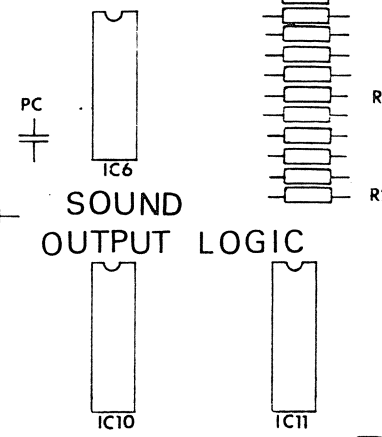
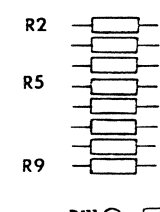
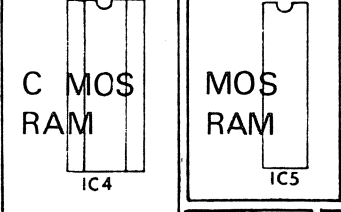
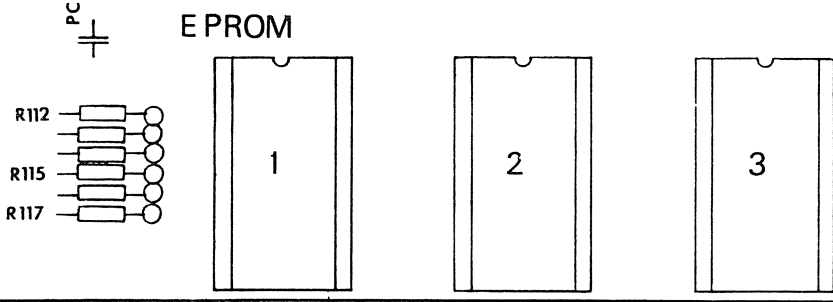
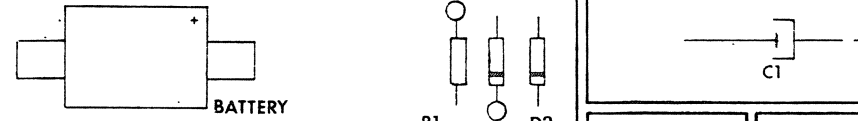

SOUND BOARD

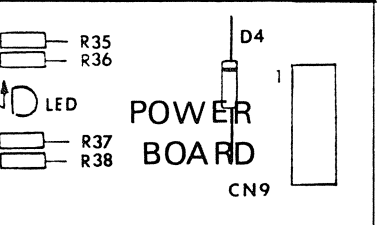
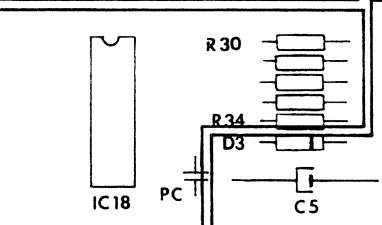
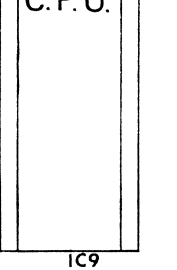
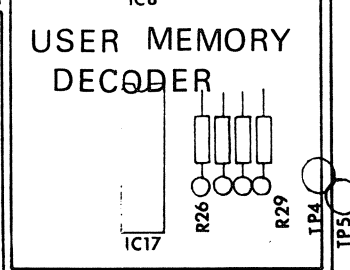
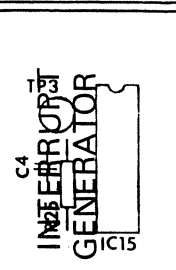
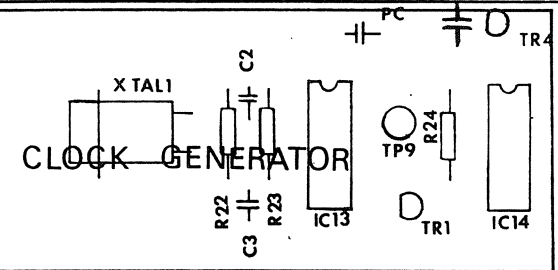

DISPLAY BOARD

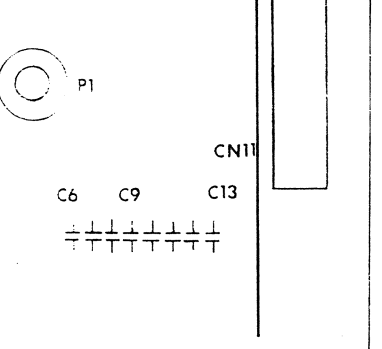
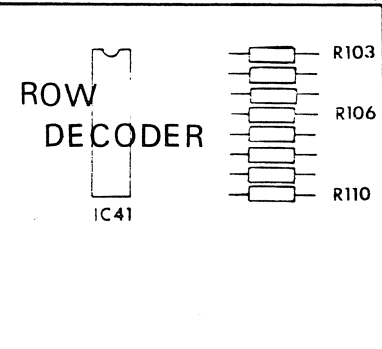
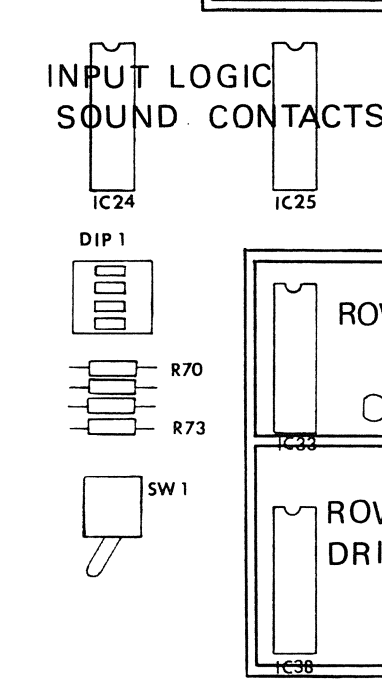
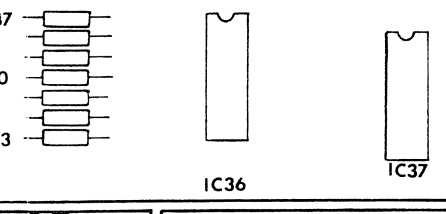
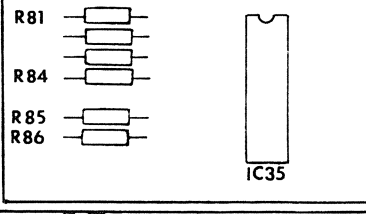
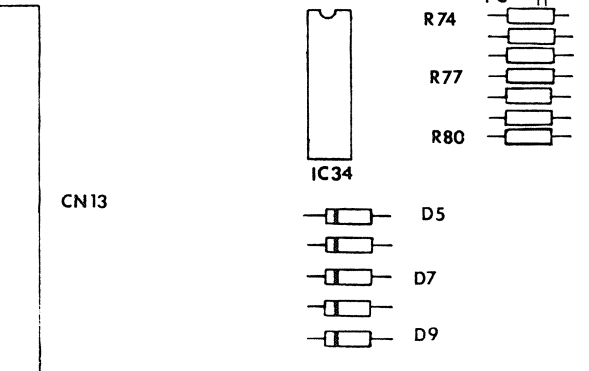
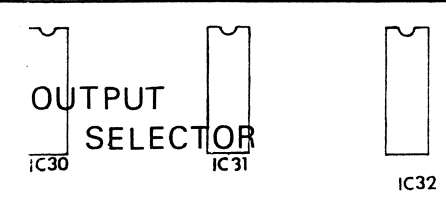
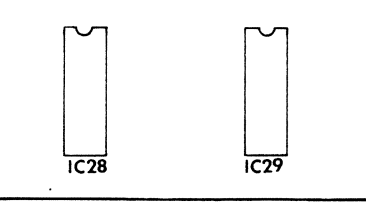
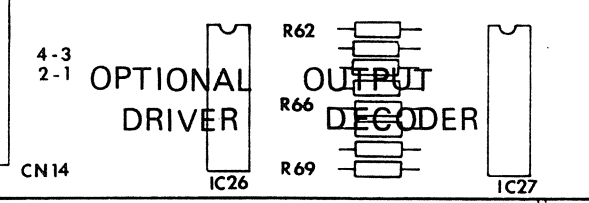
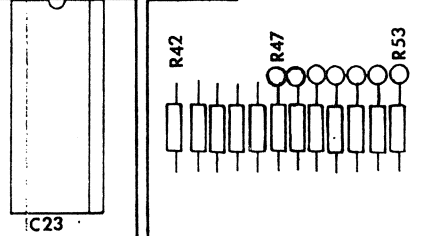
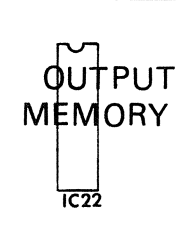
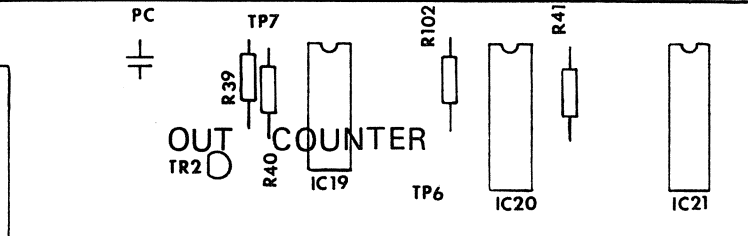

INTERFACE BOARD

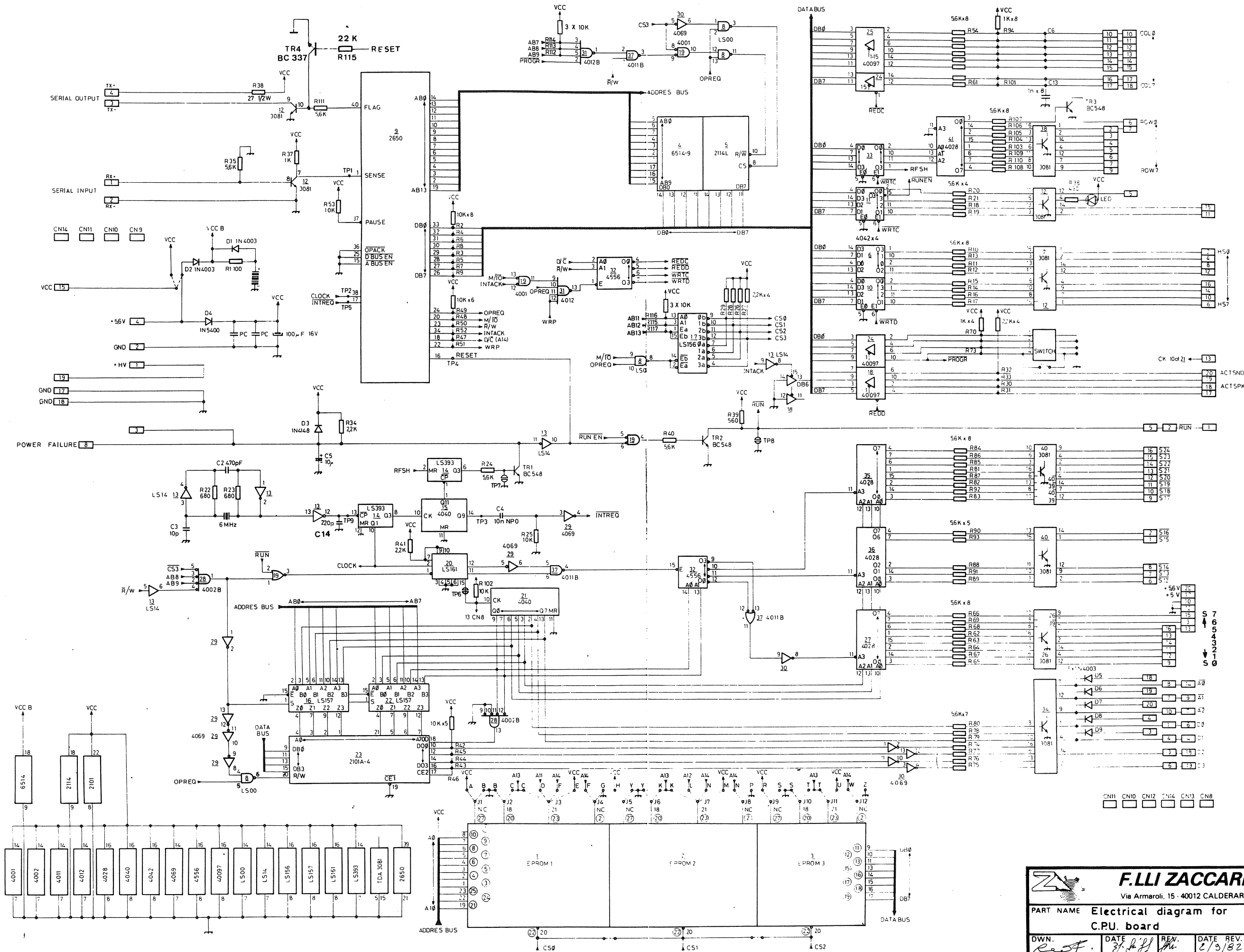

 <b>F.LI ZACCARIA s.n.c.</b> Via Armadori, 15 - 40012 CALDERARA DI RENO (Bo) Italy		PART NO. 1B 13 65/1	
PART NAME		ELECTRICAL diagram for	
C.P.U. board		SHEET	
DWN. <i>Rest.</i>	DATE <i>2/3/82</i>	REV. <i>1/1</i>	DATE REV. <i>2/3/82</i>
NOTES UNLESS OTHERWISE SPECIFIED			
1) ALL RESISTORS VALUES IN			
2) ALL CAPACITORS VALUES IN			

# INTERFACE BOARD

P.C. 1B1166

C.P.U. BOARD

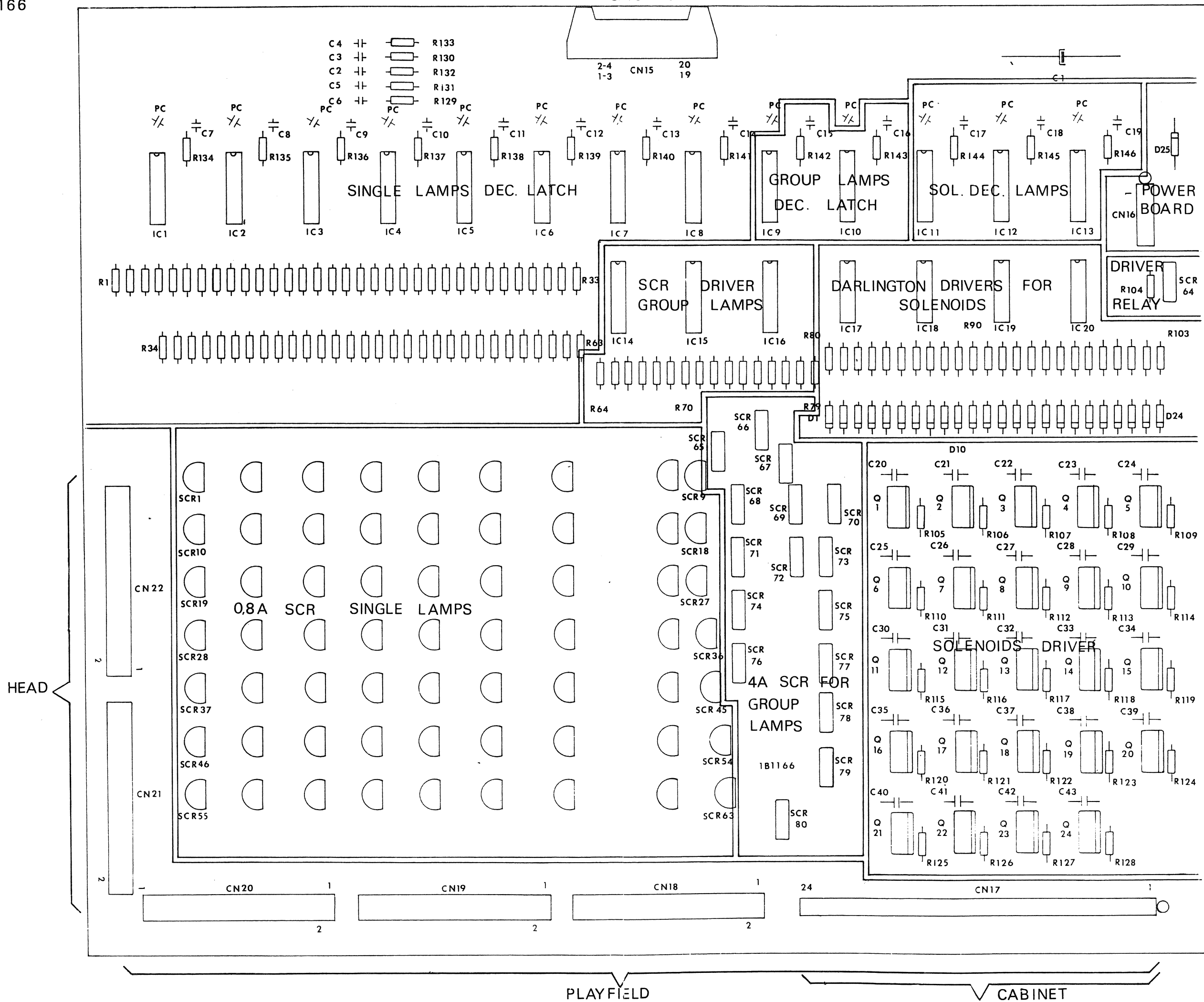

PLAYFIELD

CABINET

USES  
TO Q-7  
REPLACE  
Q-X

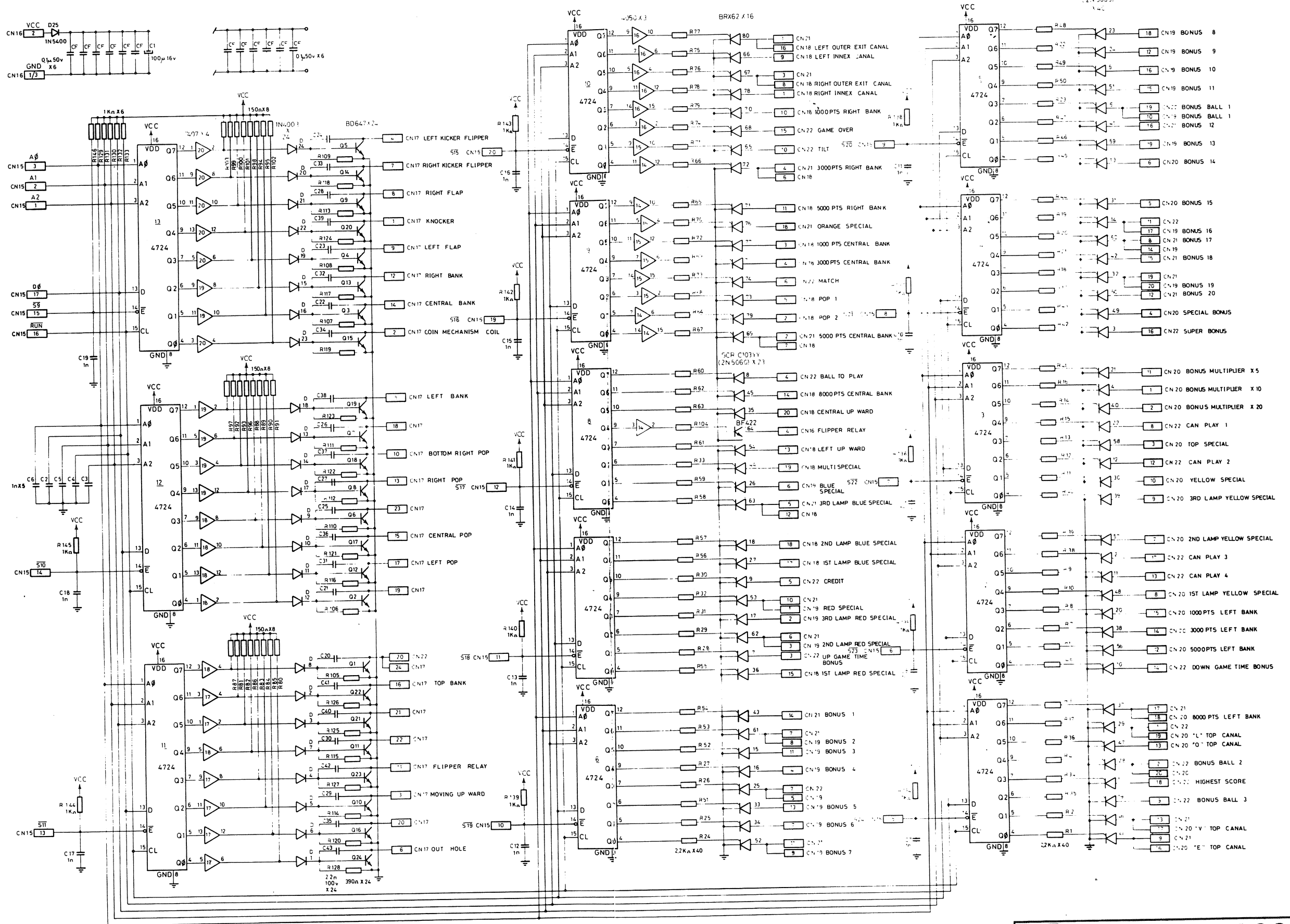

 <b>F.LLI ZACCARIA</b> s		Via Armaroli, 15 - 40012 CALDERARA DI RENO (Bo)		
		<b>INTERFACE "FARFALLA"</b>		
Codice	Descrizione			
Codice Gruppo	Dis.	Data	Rev.	Data
Materiale		Trattamento		Scala
note				Foglio

# POWER BOARD

P.C. 1B1167/0

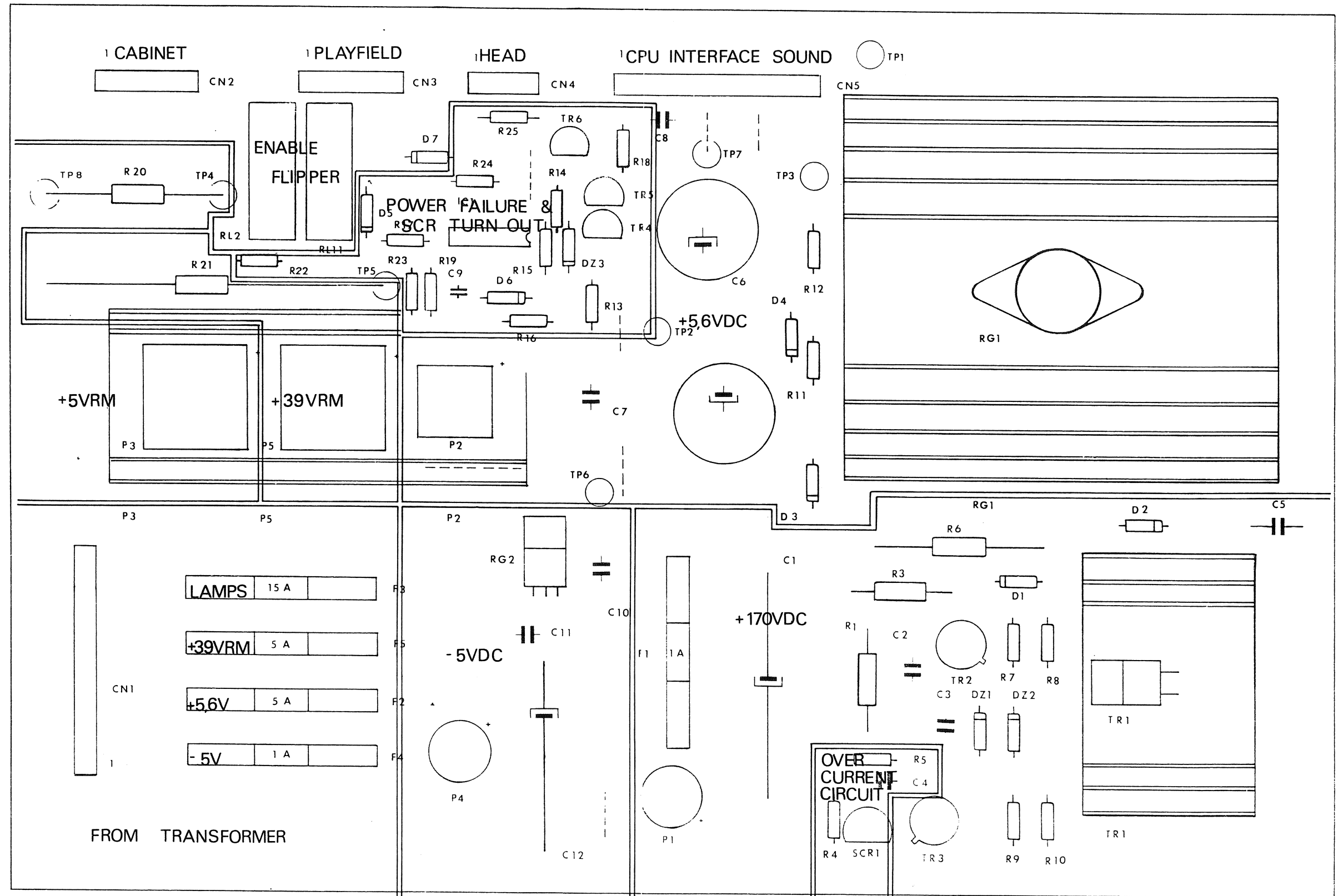

.n.c.  
ITALY

Rev.

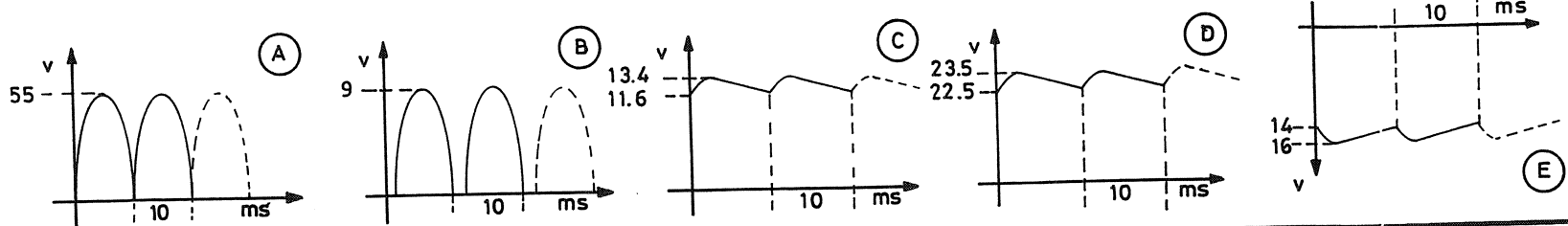
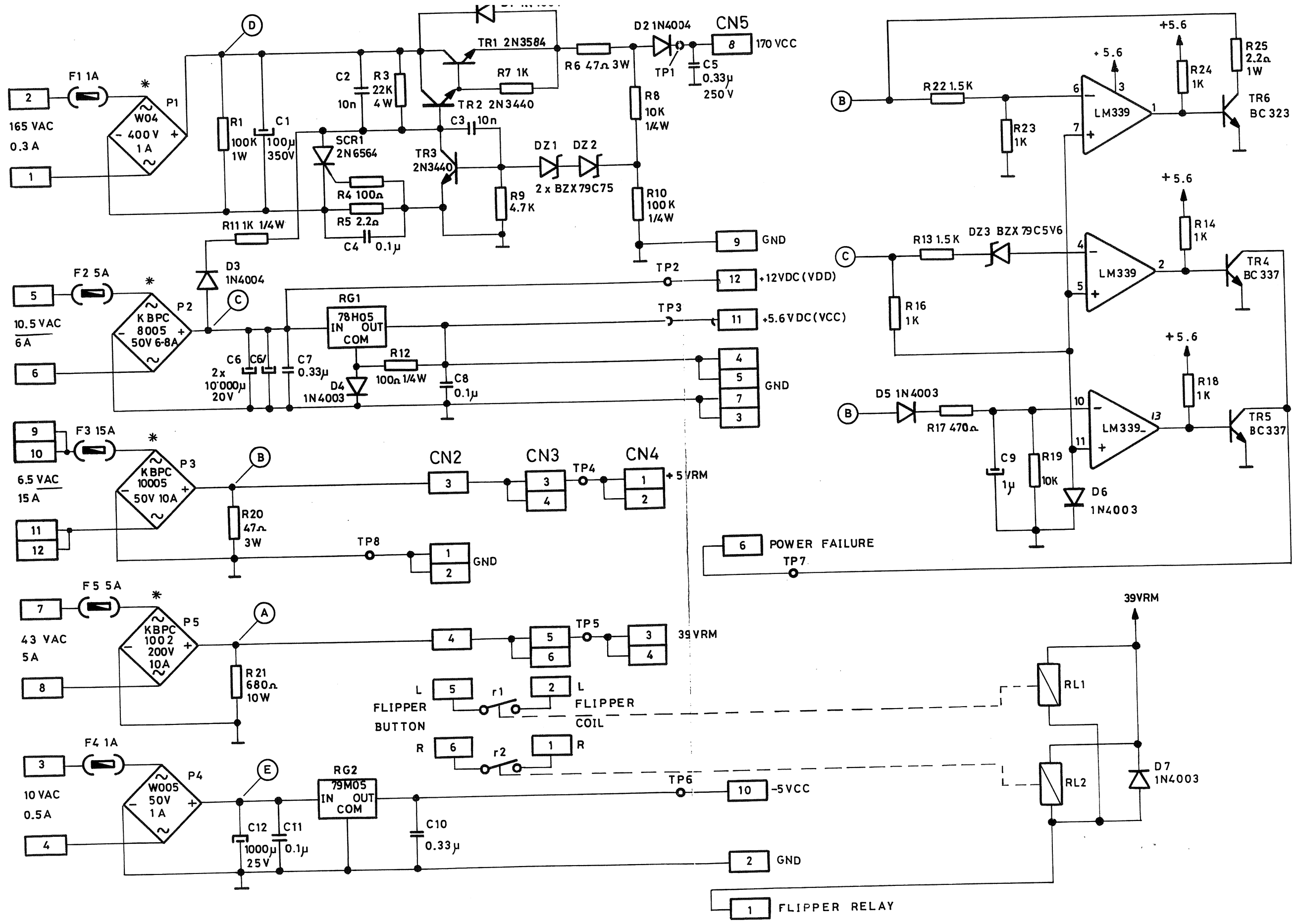

\* WITH HEAT SINK

<b>F.LLI ZACCARIA s.n.c.</b>	
Via Armadori, 15 - 40012 CALDERARA DI RENO (Bo) Italy	
PART NAME <b>Electrical diagram for POWER BOARD</b>	
PART NO. <b>1B1367/0</b>	
DWN	DATE <b>26/7/82</b>
REV. <b>1</b>	DATE REV. <b>2.2.82</b>
SHEET	
NOTES: UNLESS OTHERWISE SPECIFIED	
1) ALL RESISTORS VALUES IN	
2) ALL CAPACITORS VALUES IN	



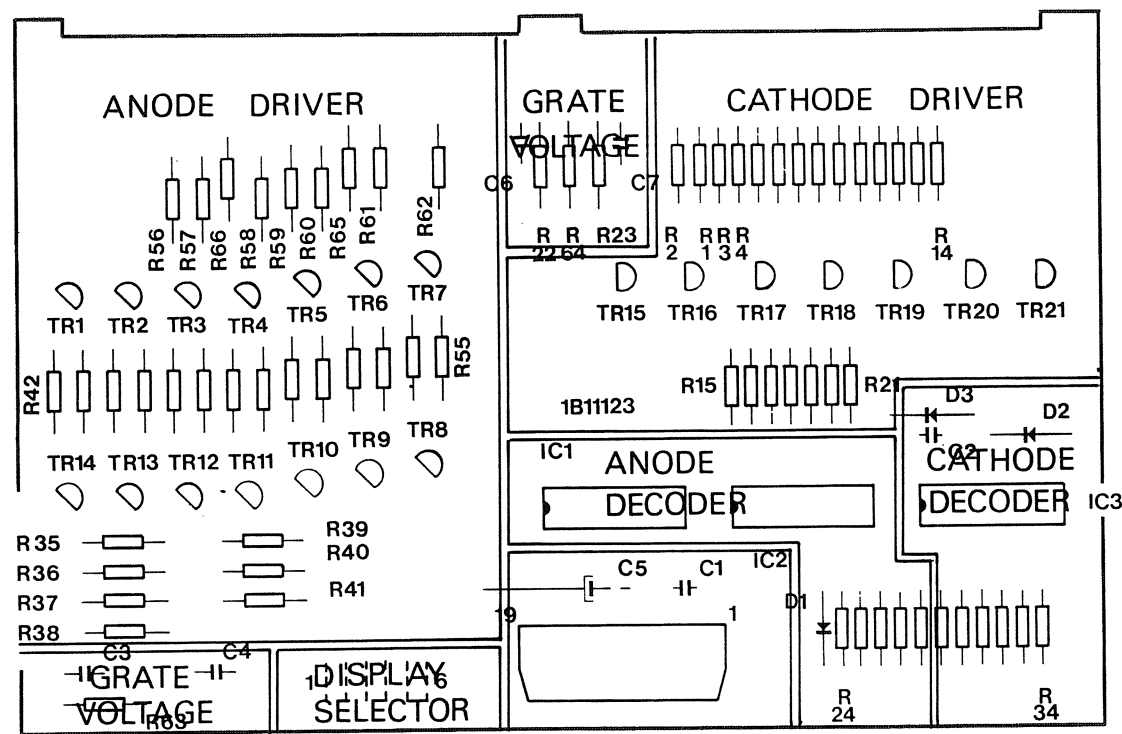

C.P.U. BOARD

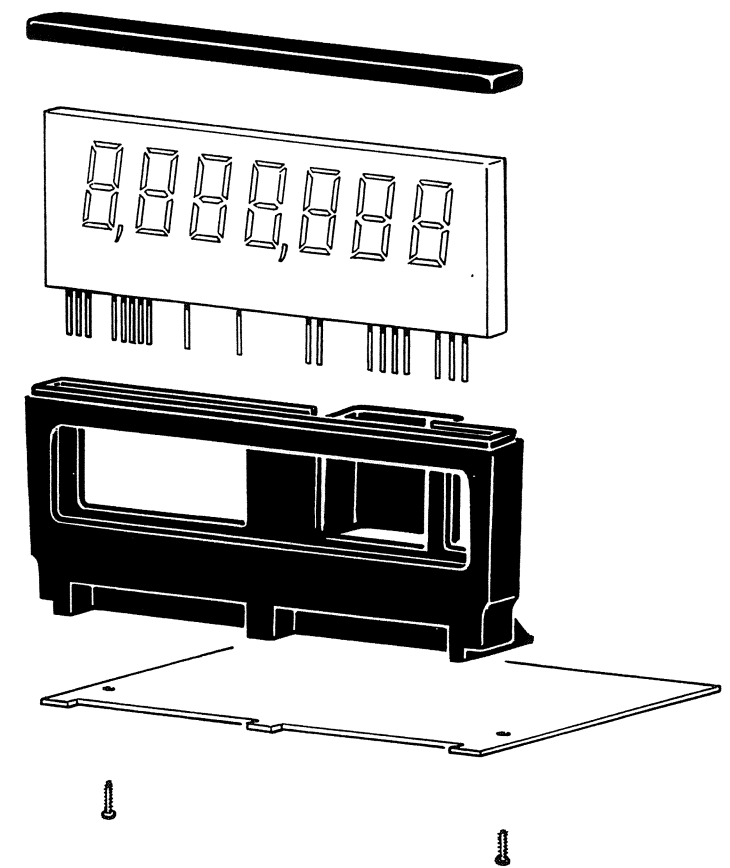

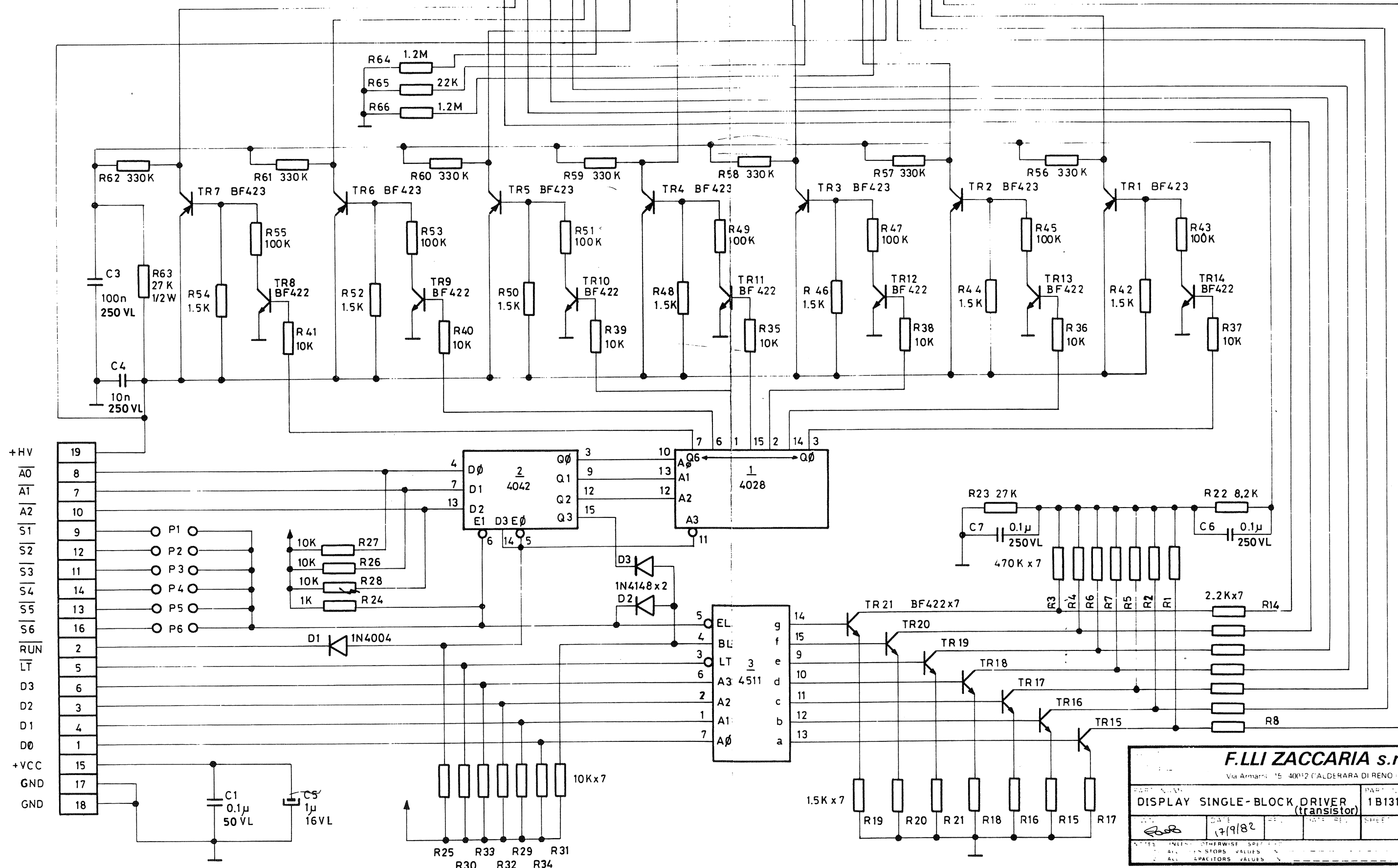
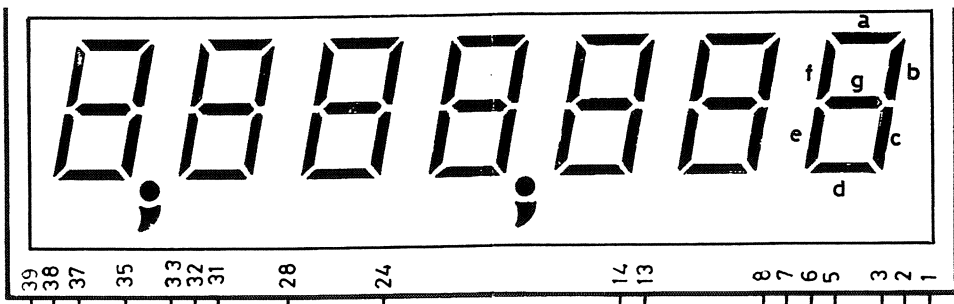

**F.LLI ZACCARIA s.n.c.**  
Via Amari 15 40012 CALDERARA DI RENO (Bo) Italy

PART. NAME <b>DISPLAY SINGLE-BLOCK DRIVER (transistor)</b>		PART. NO. <b>1B13123</b>	
DATE 7/9/82	REV.	DATE REV.	SHEET
<small>NOTES: UNLESS OTHERWISE SPECIFIED ALL DIMENSIONS ARE IN MILLIMETERS UNLESS OTHERWISE SPECIFIED ALL DIMENSIONS ARE IN MILLIMETERS UNLESS OTHERWISE SPECIFIED ALL DIMENSIONS ARE IN MILLIMETERS UNLESS OTHERWISE SPECIFIED</small>			

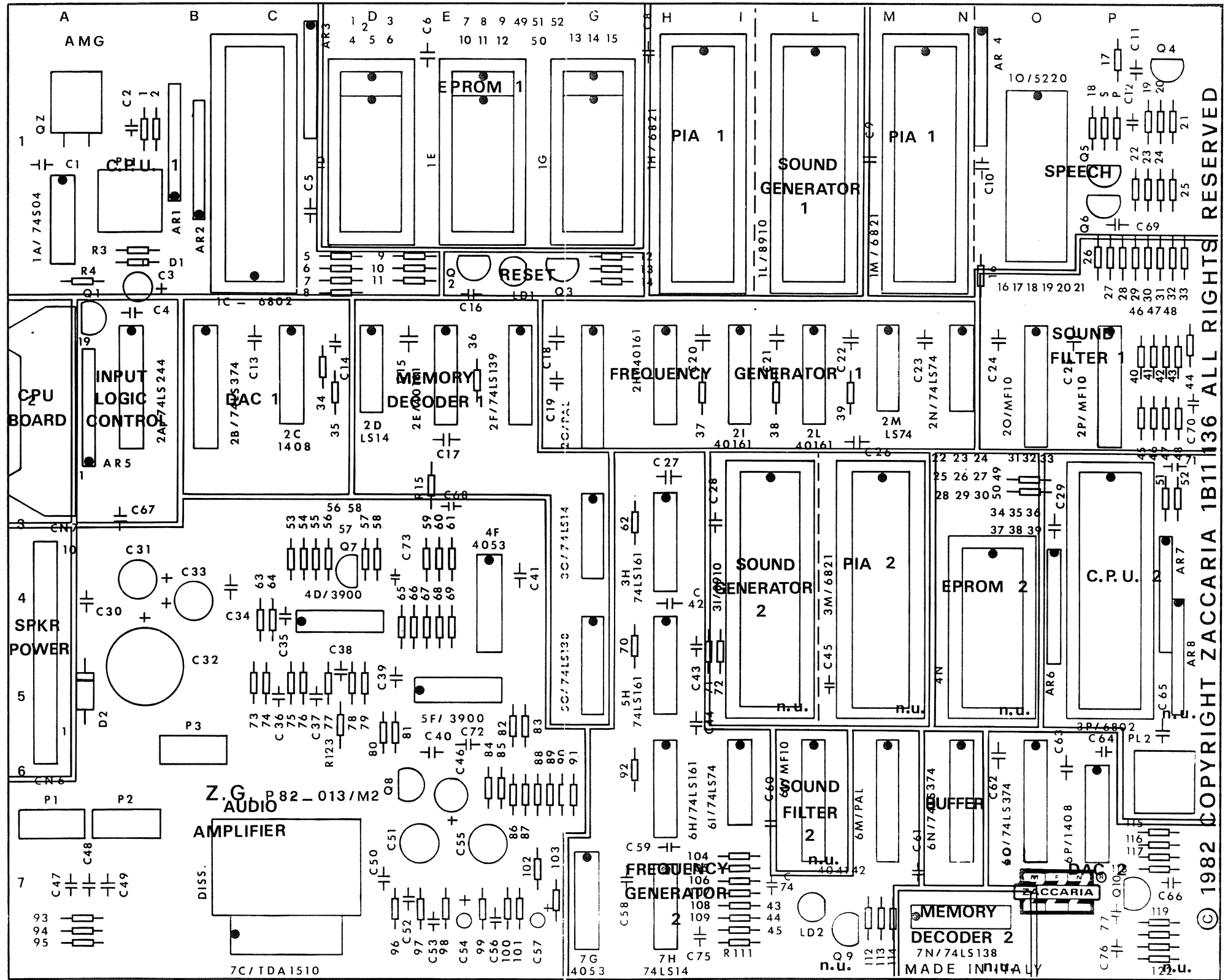

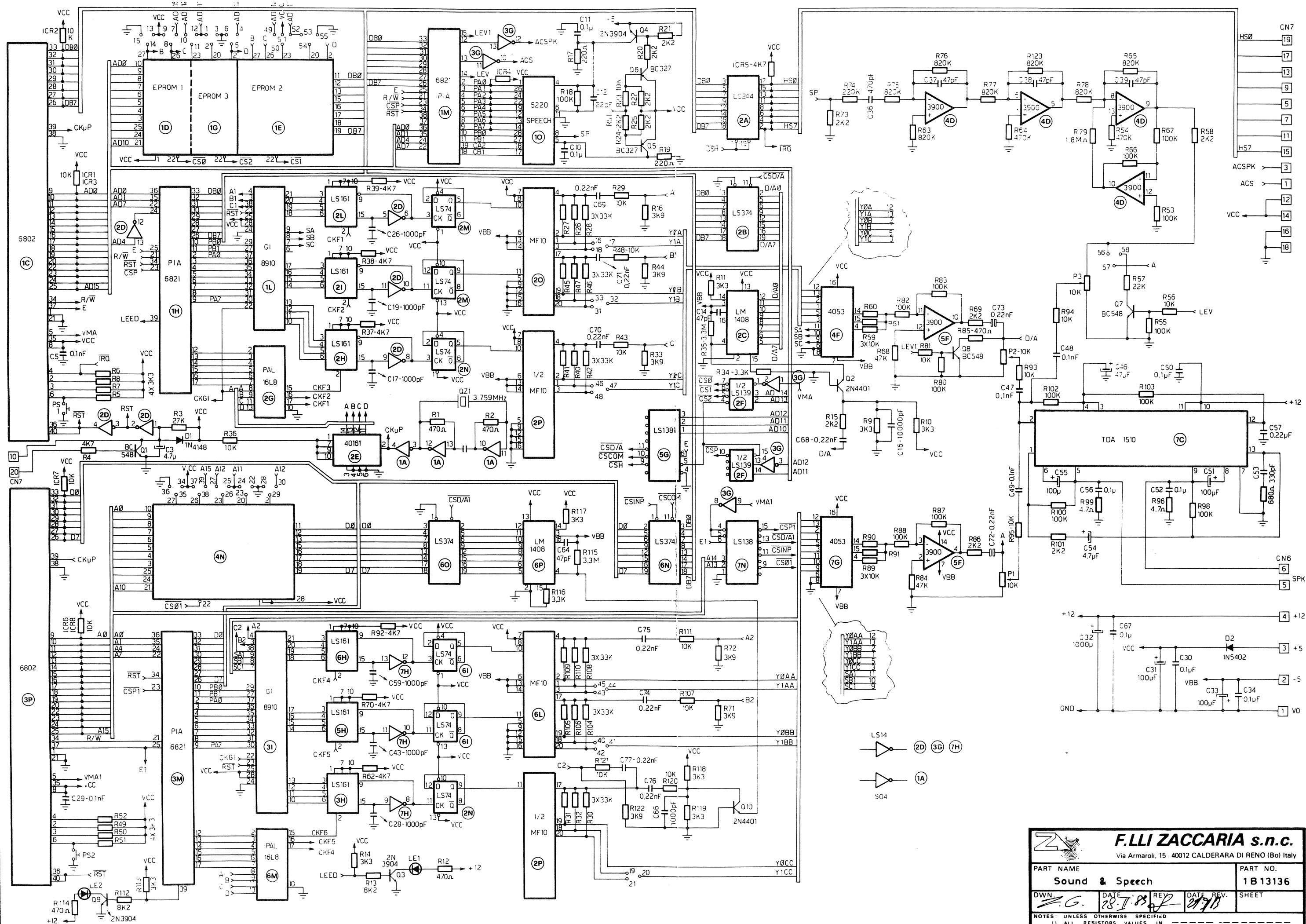

**F.LLI ZACCARIA s.n.c.**  
Via Armadori, 15 - 40012 CALDERARA DI RENO (Bo) Italy

PART NAME		PART NO.	
Sound & Speech		1B13136	
DWN. <i>Z.G.</i>	DATE <i>28/1/85</i>	REV. <i>2</i>	DATE REV. <i>27/1/85</i>
SHEET		SHEET	

NOTES: UNLESS OTHERWISE SPECIFIED  
1) ALL RESISTORS VALUES IN \_\_\_\_\_  
2) ALL CAPACITORS VALUES IN \_\_\_\_\_

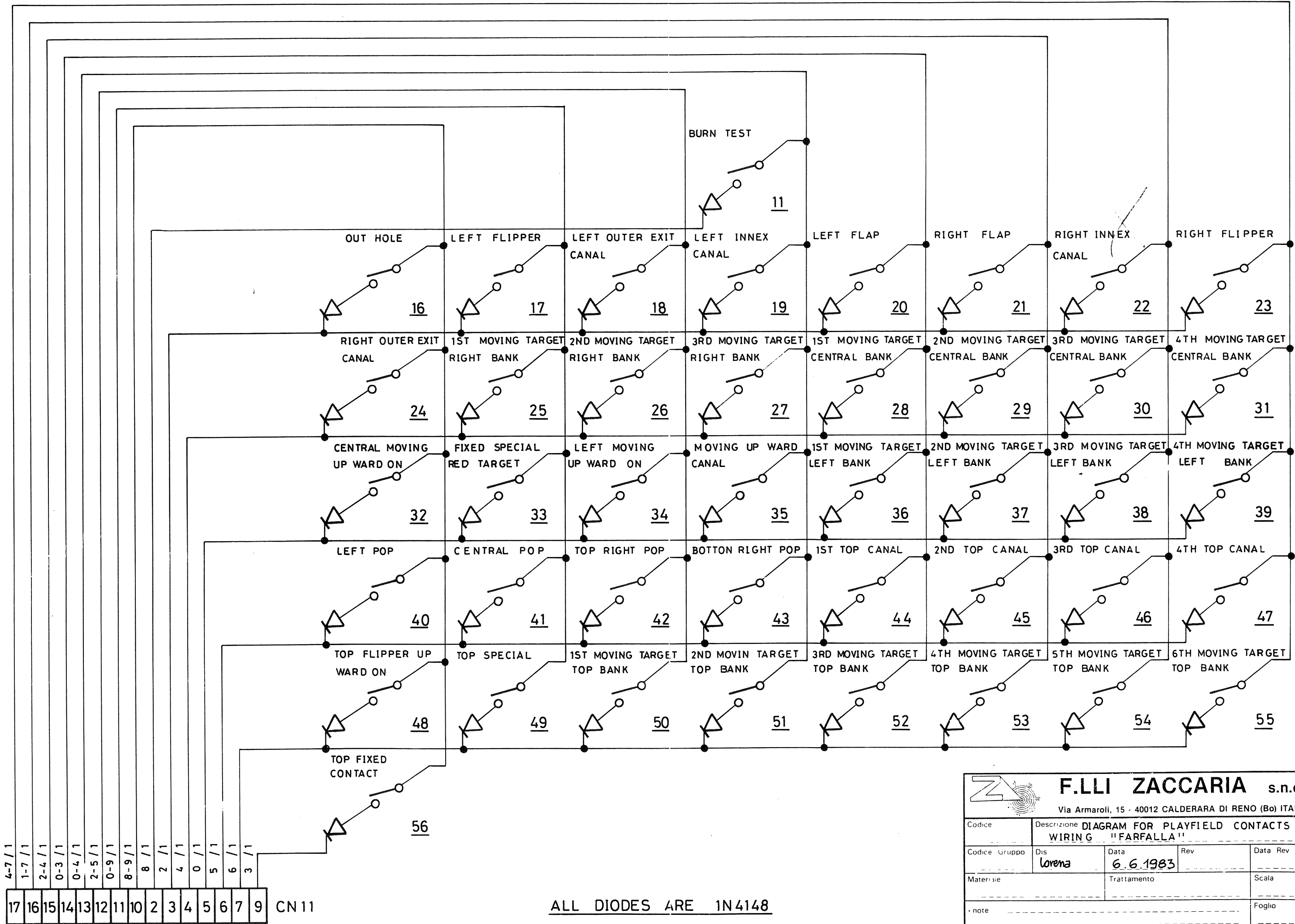

		<b>F.LLI ZACCARIA s.n.c.</b> Via Armaroli, 15 - 40012 CALDERARA DI RENO (Bo) ITALIA			
		Codice Descrizione <b>DIAGRAM FOR PLAYFIELD CONTACTS WIRING "FARFALLA"</b>			
Codice Gruppo	Dis	Data	Rev	Data Rev	
	Lorena	6.6.1983			
Materie			Trattamento	Scala	
note					Foglio

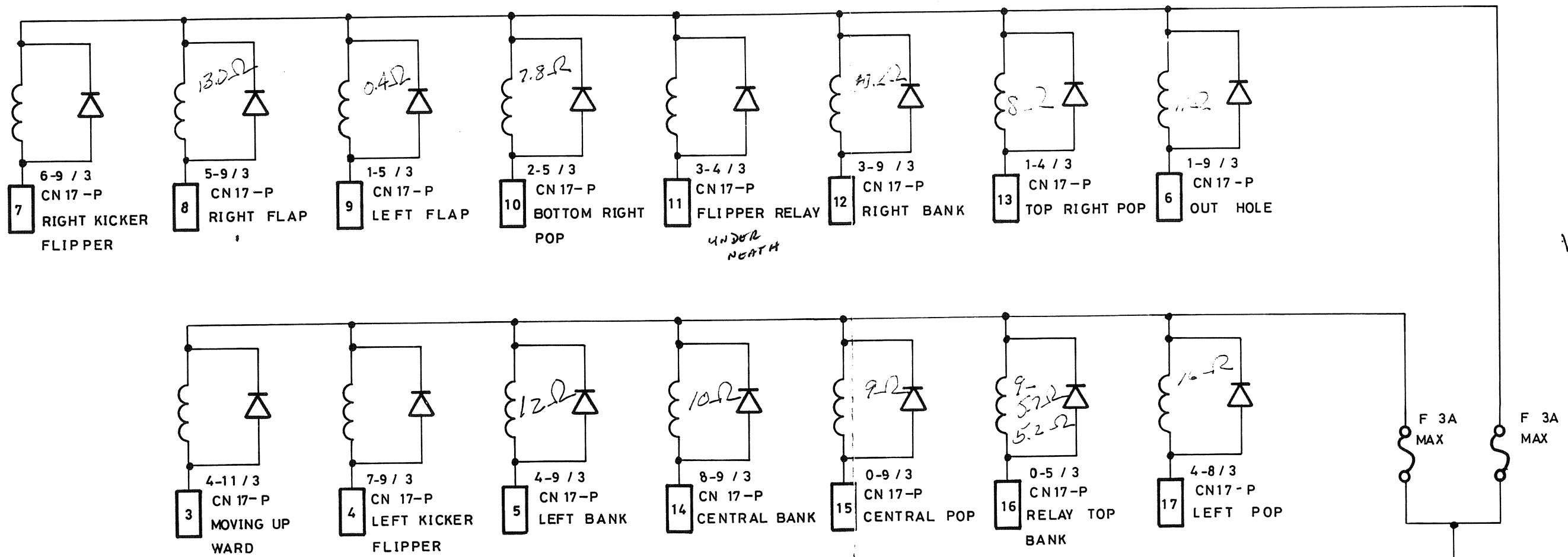

10-20 OHMS  
UNDER  
4

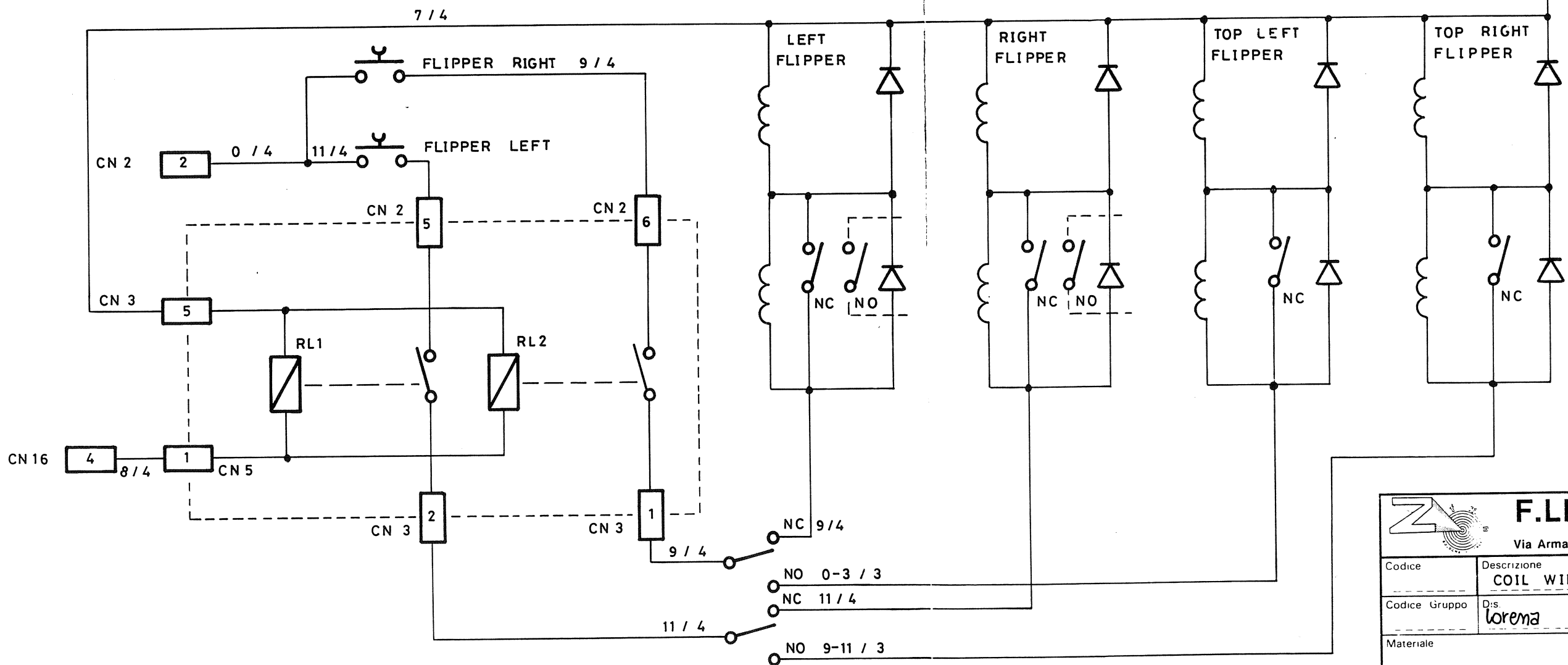

		<b>F.LLI ZACCARIA s.n.c.</b>		
		Via Armaroli, 15 - 40012 CALDERARA DI RENO (Bo) ITALY		
Codice	Descrizione COIL WIRING "FARFALLA"			
Codice Gruppo	D:s lorema	Data 8.6.1983	Rev	Data Rev
Materiale	Trattamento		Scala	
note				Foglio

### PLAYFIELD LAMPS

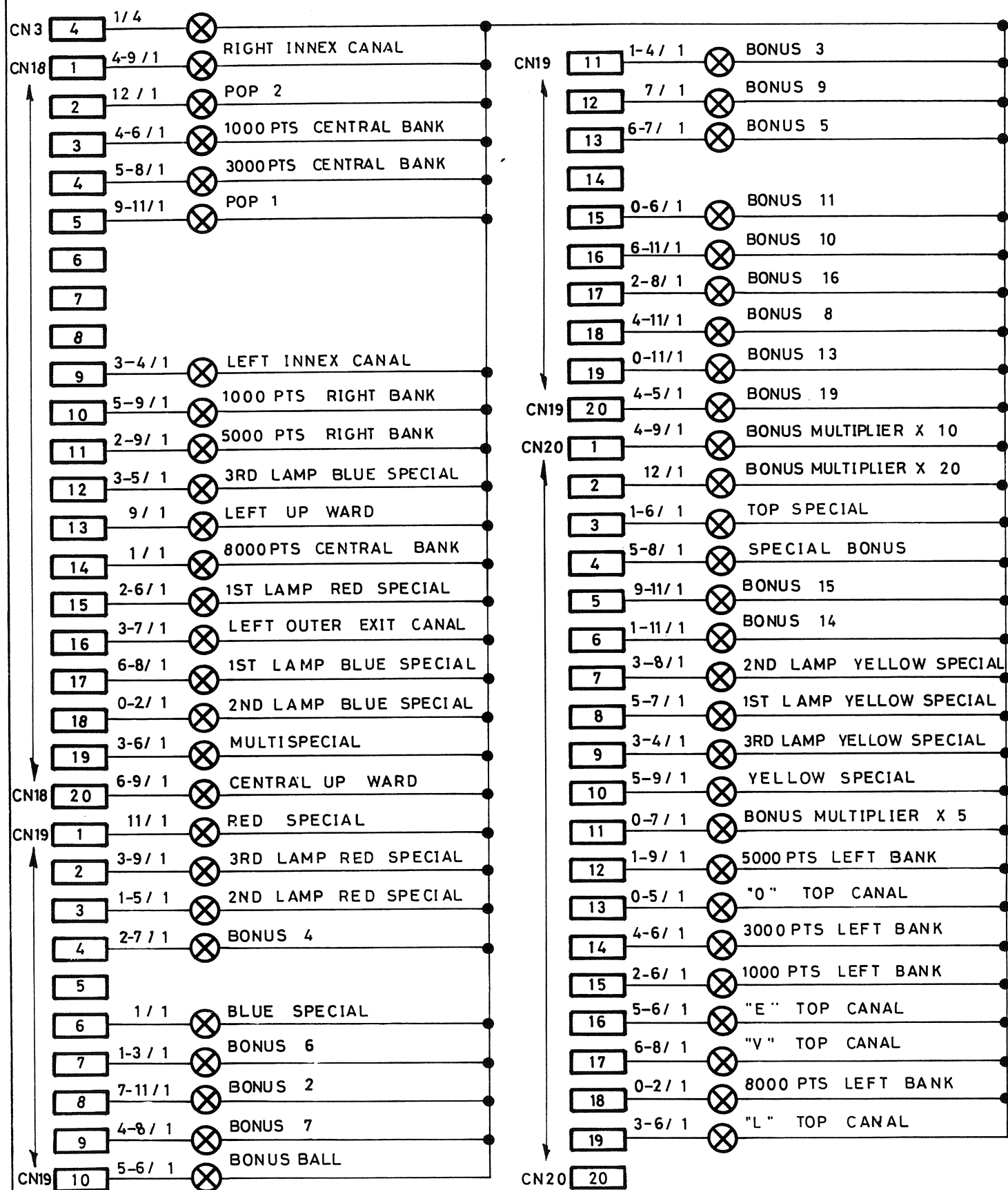

### HEAD LAMPS

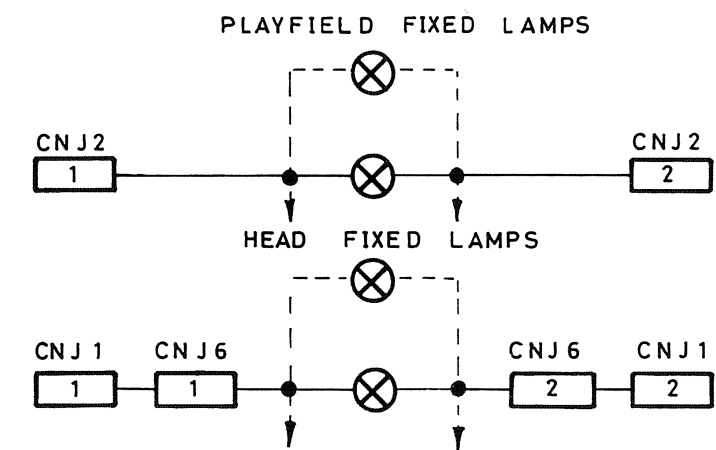
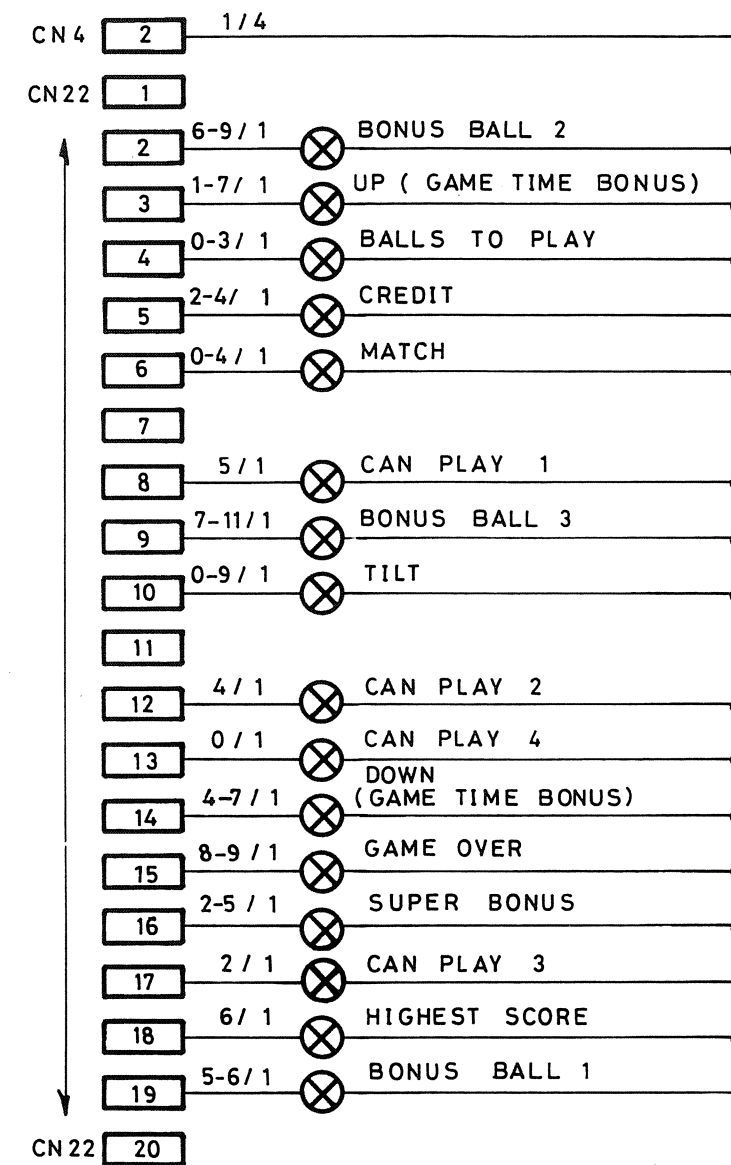

**F.LLI ZACCARIA s.**  
Via Armadori, 15 - 40012 CALDERARA DI RENO (Bo)

Codice	Descrizione <b>ELECTRICAL DIAGRAM FOR PLAYFIELD &amp; HEAD LAMPS "FARFALLA"</b>			
Codice Gruppo	Dis <b>lorena</b>	Data <b>9.6.1985</b>	Rev	Data F
Materiale	Trattamento			Scala
note				Foglio

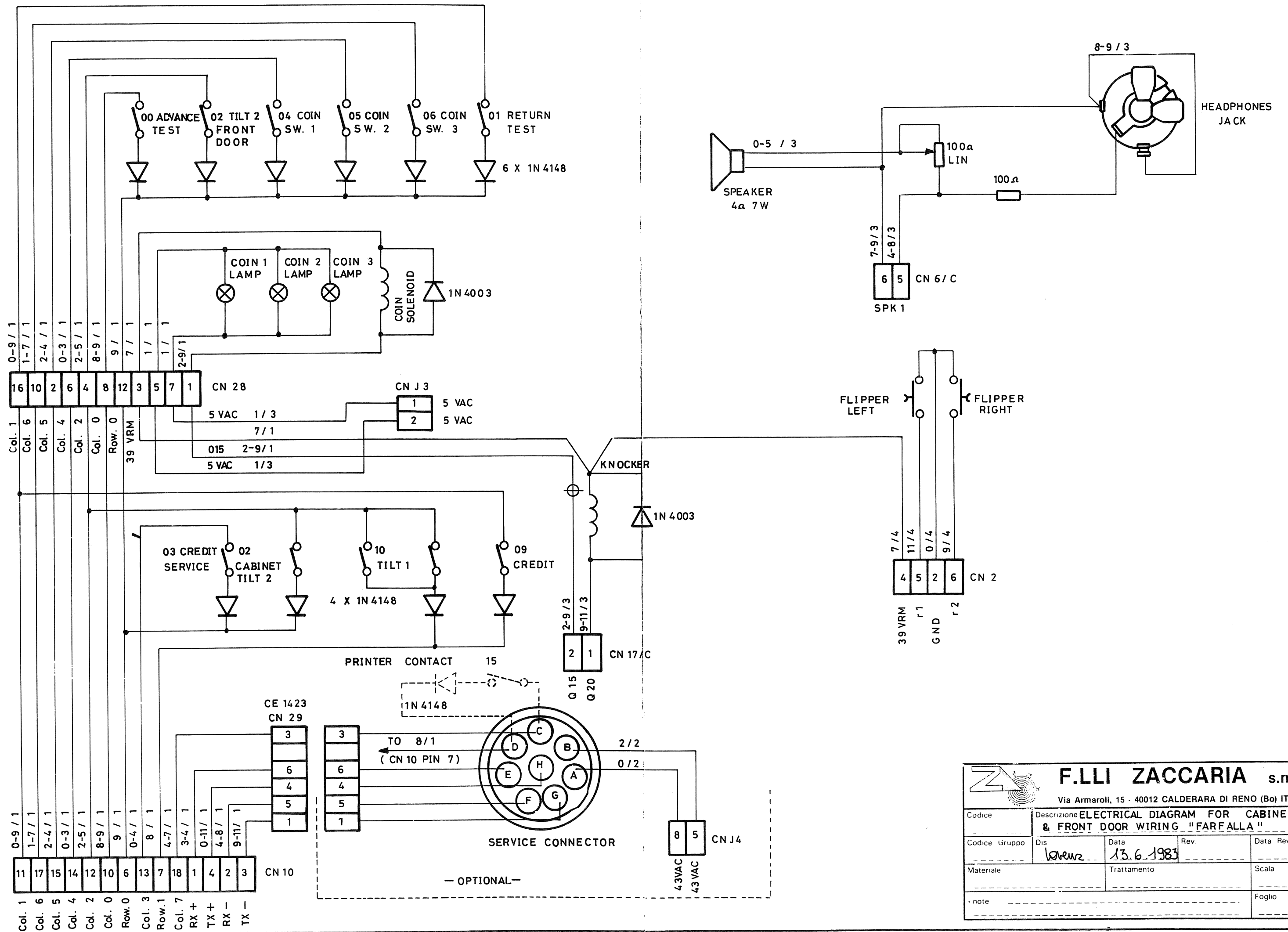

		<b>F.LLI ZACCARIA s.n.c.</b>			
		Via Armaroli, 15 - 40012 CALDERARA DI RENO (Bo) ITALY			
Codice	Descrizione <b>ELECTRICAL DIAGRAM FOR CABINET &amp; FRONT DOOR WIRING "FARFALLA"</b>				
Codice Gruppo	Dis.	Data	Rev.	Data Rev.	
	laurenz	13.6.1983			
Materiale	Trattamento			Scala	
note					Foglio